

STOCK

Büroeinrichtungen



CLOISONNETTES

+SOLUTIONS ACOUSTIQUES



TARIF

OFFICE SCREENS

+ACOUSTIC SOLUTIONS



PRICE LIST

STELLWÄNDE

+AKUSTISCHE LÖSUNGEN



PREISLISTE

2023



TARIF 2023

Pour la France et les DROM-COM, les prix indiqués sont HT et hors éco-contribution. Cette contribution sera indiquée sur l'offre de prix ou à la commande et ajoutée à la facture.



2023 PRICE LIST

VAT excl.



PREISLISTE 2023

MwSt. frei

FABRICATION
FRANCAISE
DEPUIS 1984

MADE IN
FRANCE
SINCE 1984

FRANZÖSISCHE
PRODUKTION
SEIT 1984

40% DE LA
PRODUCTION
EXPORTEE

40% OF THE
PRODUCTION IS
EXPORTED

40% DER
ERZEUGNISSE
EXPORTIERT

PLUS DE 500
REVENDEURS
EN EUROPE

OVER 500
DEALERS IN
EUROPE

MEHR ALS 500
HÄNDLER IN
EUROPA



Piètements & roulettes
Feet & castors
Füße & Rollen **30**

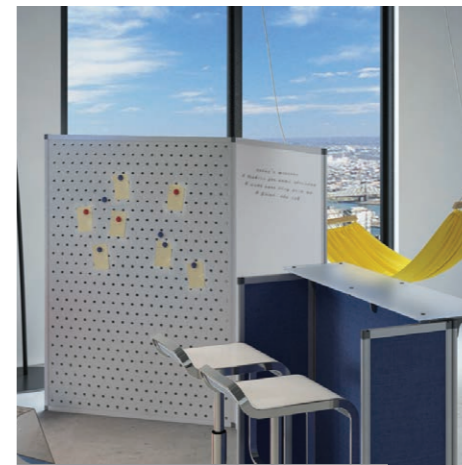

Tôle perforée magnétique
Magnetic perforated metal sheet
Magnetisch Lochblech **32**



Panneaux pour banque d'accueil
Panels for reception desk
Wände für Empfangstheke **33**

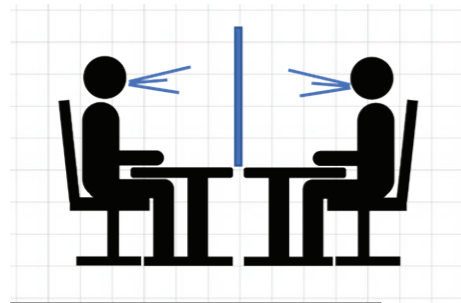

Protections COVID-19
COVID-19 protections
COVID-19 Schutzwände **6 & 25**

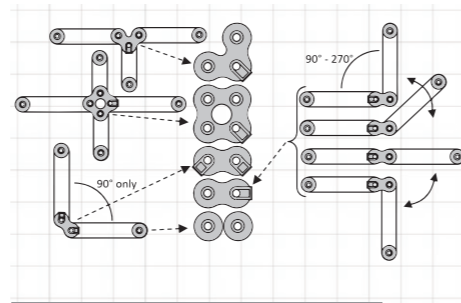

Système d'assemblage
Assembly system
Montagesystem **8**

Available on
pCon
PLANNER



Mélaminé
Melamine
Melamin **10**



Tissu
Fabric
Stoff **14**



Acoustique
Acoustic
Akustik **20**



Postes de travail & Call Center
Workstations & Call center
Arbeitsplätze & Call Center **34**



Réhausse + écran en verre
Glass desk screen + topper
Glaswände + Aufsatz **38**



Accessoires
Accessories
Zubehör **40**



Super-Acoustique
Super-Acoustic
Super-Akustik **22**



Verre acrylique + Polycarbonate
Acrylic glass & Polycarbonate
Acrylglas & Polycarbonat **24**



Panneaux d'affichage magnétiques
Magnetic notice boards
Magnetische Anschlagtafeln **28**



Solutions acoustiques
Acoustic solutions
Akustische Lösungen **42**



Cloisons mobiles sur roulettes
Freestanding screens on castors
Bewegliche Wände auf Rollen **44**



Conditions de transport
Conditions of transport
Beförderungsbedingungen **46**

 **PROTECTIONS COVID-19**

 **COVID-19 PROTECTIONS**

 **COVID-19 SCHUTZWÄNDE**

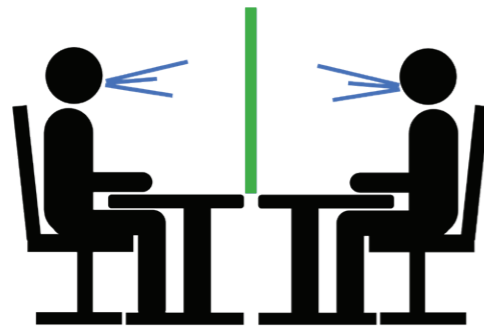

Voir pages 25-27

See pages 25-27

Siehe Seiten 25-27

Verre acrylique incolore 3 ou 4mm
Dimensions standards ou sur mesure

Dimensions **maximum** conseillées :
Epaisseur 3mm **Ref. PX3** : 800 x 800 mm
Epaisseur 4mm **Ref. PX4** : 1000x1000mm
Découpe sur mesure, veuillez nous consulter

3 or 4mm colourless acrylic glass
Standard or custom dimensions

Maximum dimensions:
3mm thick **Ref. PX3**: 800 x 800 mm
4mm thick **Ref. PX4**: 1000 x 1000mm
Cut to size, please contact us

3 oder 4mm Klaracrylglas
Standard- oder benutzerdefinierte Abmessungen

Maximale Abmessungen:
3mm dick **Ref. PX3**: 800 x 800 mm
4mm dick **Ref. PX4**: 1000 x 1000mm
Zuschnitt nach Maß, kontaktieren Sie uns



Hauteur
Height
Höhe

390 mm

- Ref. PX3 390 x 50 **7 €**
- Ref. PX4 390 x 50 **8 €**
- Ref. PX3 390 x 100 **9 €**
- Ref. PX4 390 x 100 **10 €**
- Ref. PX3 390 x 150 **11 €**
- Ref. PX4 390 x 150 **12 €**

590 mm

- Ref. PX3 590 x 50 **8 €**
- Ref. PX4 590 x 50 **9 €**
- Ref. PX3 590 x 100 **10 €**
- Ref. PX4 590 x 100 **11 €**
- Ref. PX3 590 x 150 **12 €**
- Ref. PX4 590 x 150 **13 €**



Hauteur
Height
Höhe

590 mm

- Ref. PX3 590 x 190 **11 €**
- Ref. PX4 590 x 190 **13 €**
- Ref. PX3 590 x 390 **23 €**
- Ref. PX4 590 x 390 **25 €**
- Ref. PX3 590 x 590 **36 €**
- Ref. PX4 590 x 590 **38 €**
- Ref. PX3 590 x 790 **47 €**
- Ref. PX4 590 x 790 **49 €**

790 mm

- Ref. PX3 790 x 190 **15 €**
- Ref. PX4 790 x 190 **17 €**
- Ref. PX3 790 x 390 **32 €**
- Ref. PX4 790 x 390 **34 €**
- Ref. PX3 790 x 590 **47 €**
- Ref. PX4 790 x 590 **49 €**
- Ref. PX3 790 x 790 **64 €**
- Ref. PX4 790 x 790 **66 €**

Connecteur
pour verre acrylique de 3 ou 4mm



Ref. PLE 204 **10 €**

Connector
for 3 or 4mm acrylic glass



Ref. PLE 202 **8 €**

Verbinder
für 3 oder 4mm Acrylglas



Ref. PLE 203 **9 €**



Ref. PLE 222 **13 €**

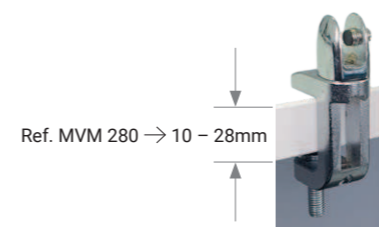
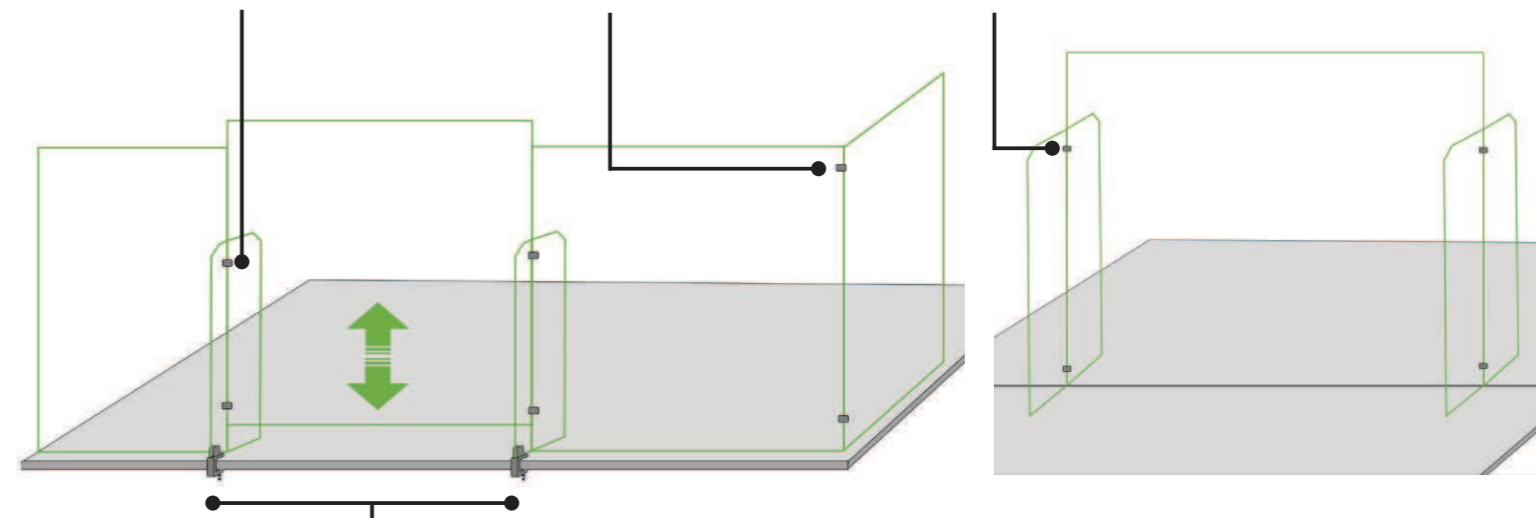

Ref. MVM 280 → 10 - 28mm

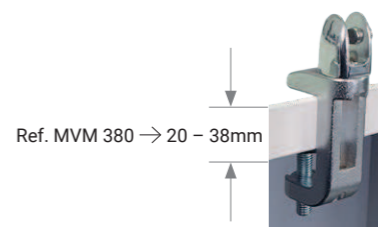

Ref. MVM 380 → 20 - 38mm

Ref. MVM 280 **29 €**

Ref. MVM 380 **29 €**

Pince bureau métallique
+ clip pour verre acrylique de 3 ou 4 mm

Metal desk clamp
+ clip for 3 or 4mm acrylic glass

Tischklammer
+ Klip für 3 oder 4mm Acrylglas

SYSTÈME D'ASSEMBLAGE

ASSEMBLY SYSTEM

MONTAGE-SYSTEM

FICHE TECHNIQUE

TECHNICAL DATA

TECHNISCHEN DATEN

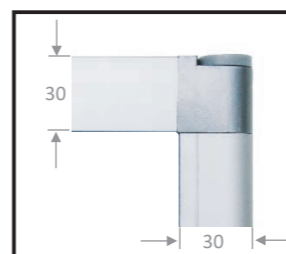
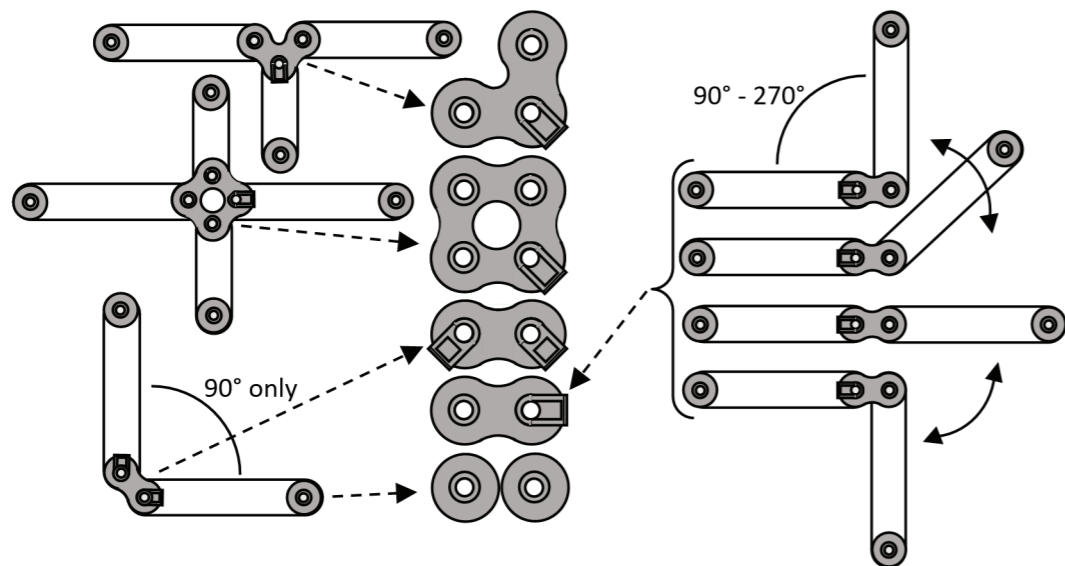
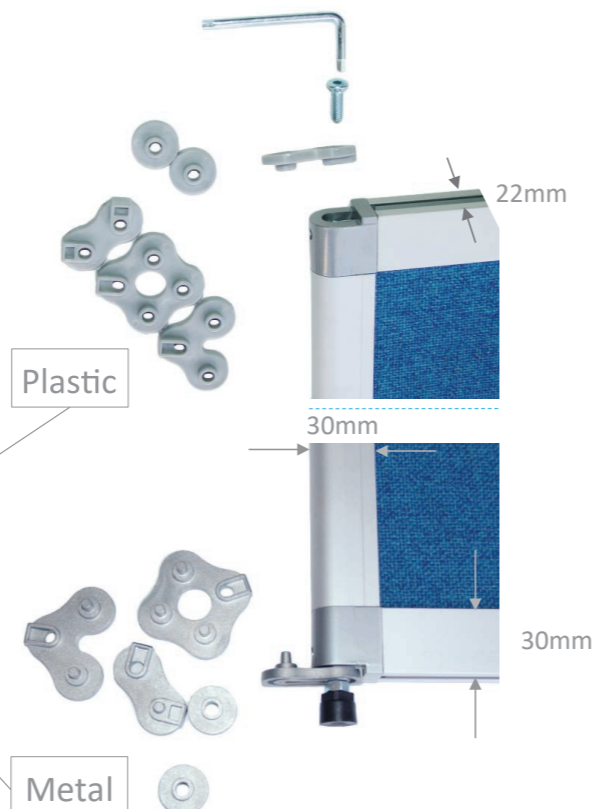
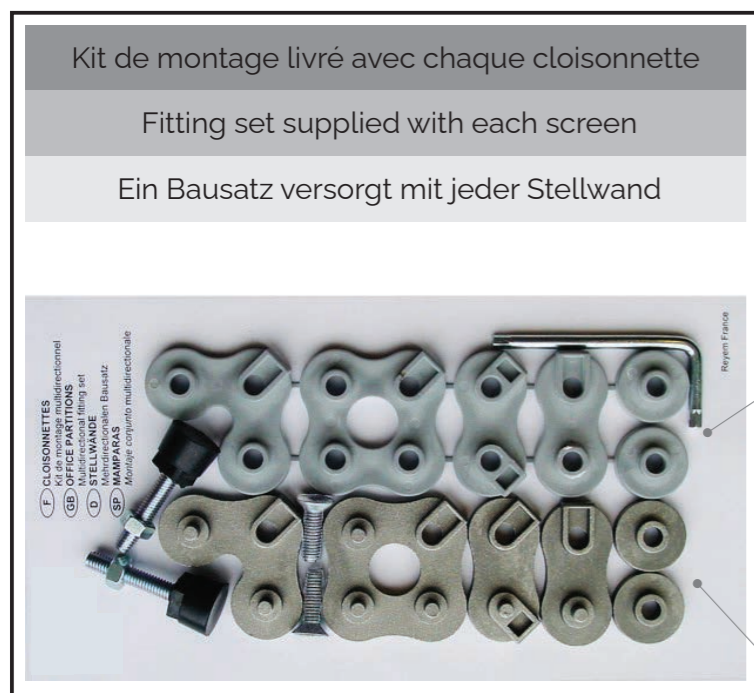
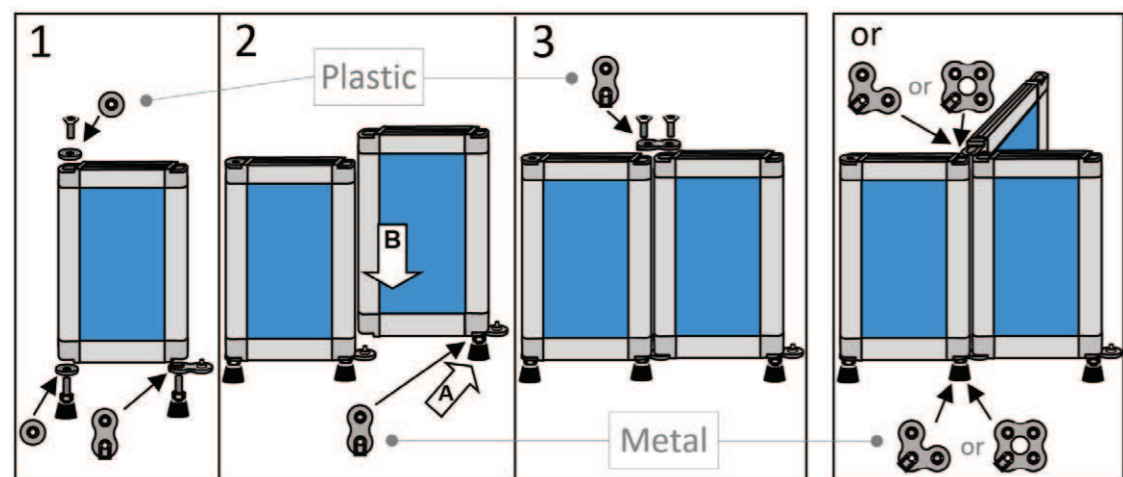

OSSATURE
Toutes les cloisons Reyem sont fabriquées avec une ossature en aluminium anodisé nature de 30mm, d'épaisseur 22mm et assemblées avec des pièces d'angle en alliage de zinc, peinture liquide RAL 9006.

FRAME
Each Reyem screen is made using a colourless, anodised aluminium frame of 30mm and 22mm thick. The frame is assembled with corner pieces made of a zinc alloy, liquid paint RAL 9006.

RAHMEN
Jede Reyem-Wand wird mit einem 30mm und 22mm dicken Rahmen aus farblosem, eloxiertem Aluminium gefertigt. Der Rahmen wird mit zinklegierten Eckstücken, flüssige Farbe RAL 9006 zusammengesetzt.

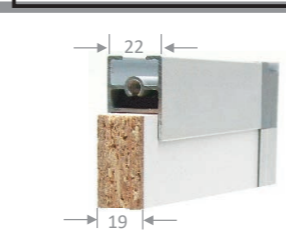

MELAMINE
Mélaminé d'épaisseur 19mm, classement au feu M3 / D, s2, d0. Classement au feu M1 / B, s2, d0 possible, veuillez nous consulter pour prix et délais. Coloris page 11

MELAMINE
19mm thick melamine, fire safety classification: D, s2, d0. Fire safety classification B, s2, d0 possible, please contact us for price and delivery time. Colours page 11

MELAMIN
19mm Melamin, Feuersicherung: D, s2, d0. Feuersicherung B, s2, d0 möglich, bitte kontaktieren Sie uns für Preis und Lieferzeit. Melaminfarben Seite 11

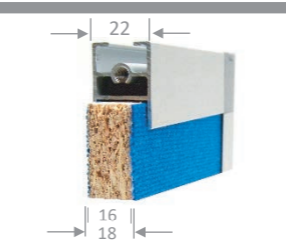

TISSU
Aggloméré de 16mm 100% PEFC et FSC
+ Colle à l'eau
+ Textile (voir page 15)
Tests acoustiques page 17

FABRIC
16mm thick chipboard 100% PEFC et FSC
+ Water glue
+ Textile (see page 15)
Acoustic tests page 17

STOFF
16mm Spanplatten 100% PEFC- und FSC-zertifiziert
+ Wasser-Leim
+ Textil (siehe Seite 15)
Akustikteste Seite 17

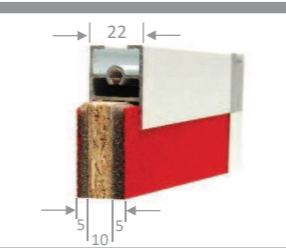

ACOUSTIQUE
Aggloméré de 10mm 100% PEFC et FSC
+ 2 x 5mm de mousse 100% polyuréthane, densité 23 kg/m3
+ Colle à l'eau
+ Textile (voir page 15)
Tests acoustiques page 17

ACOUSTIC
10mm thick chipboard 100% PEFC et FSC
+ 2 x 5mm foam 100% polyurethane, density 23 kg/m3
+ Water glue
+ Textile (see page 15)
Acoustic tests page 17

AKUSTIK
10mm Spanplatten 100% PEFC- und FSC-zertifiziert
+ 2 x 5mm Schaum 100% Polyurethan, Dichte 23 kg/m3
+ Wasser-Leim
+ Textil (siehe Seite 15)
Akustikteste Seite 17

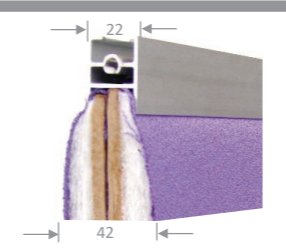

SUPER-ACOUSTIQUE
2 x 5mm de Medium Density Fibreboard (MDF)
+ 2 x 15mm de fibre 100% polyester, densité 30 kg/m3
+ Textile (voir page 15)
Tests acoustiques page 17

SUPER-ACOUSTIC
2 x 5mm thick Medium Density Fibreboard (MDF)
+ 2 x 15mm 100% polyester fibre, density 30 kg/m3
+ Textile (see page 15)
Acoustic tests page 17

SUPER-AKUSTIK
2 x 5mm Medium Density Fibreboard (MDF)
+ 2 x 15mm 100% Polyesterfaser, Dichte 30 kg/m3
+ Textil (siehe Seite 15)
Akustikteste Seite 17

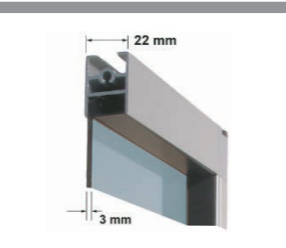

VERRE ACRYLIQUE
Finition verre acrylique 3mm. Incolore, fumé gris, ou opale, résistance durable aux UV, classement feu M4 / E.
+ Profilé de compensation en PVC noir

ACRYLIC GLASS
3mm thick acrylic glass. Colourless, gray tinted or opal, long-lasting UV resistance, fire safety classification: E.
+ compensator profile made of black PVC

ACRYLGLAS
3mm Acrylglas, Klar, grau Rauch oder Opal. Langlebig UV-beständig, Feuersicherung: E.
+ Kompensator Profil schwarz PVC



POLYCARBONATE ALVÉOLAIRE
Finition polycarbonate alvéolaire incolore 6mm. Protection UV par coextrusion, classement au feu M1 / B, s1, d0
+ Profilé de compensation en PVC

ALVEOLAR POLYCARBONATE
6mm thick colourless alveolar polycarbonate. UV protection by coextrusion, fire classification: B, s1, d0
+ compensator profile made of black PVC

POLYCARBONAT
6mm Klarpolycarbonat, UV-beständigkeit (Coextrusion), Feuersicherung Class B, s1, d0.
+ Kompensator Profil schwarz PVC

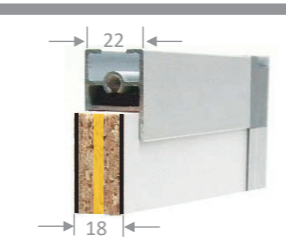

AFFICHAGE MAGNÉTIQUE
Face magnétique émaillée écrivable & effaçable blanche (disponible en 1 ou 2 faces)

MAGNETIC NOTICE BOARDS
Enameled white magnetic writable side (available on 1 or 2 sides)

MAGNETISCHE ANSCHLAGTAFELN
Emailliert weiß magnetisch und beschreibbar Seite (Verfügbar auf 1 oder 2 Seiten)



MÉLAMINÉ



MELAMINE



MELAMIN



Mé laminé d'épaisseur 19mm, fibre du bois horizontal (Epaisseur 8mm possible, voir page 45). 100% PEFC et FSC.



19mm thick melamine, wood fiber horizontal (8mm thick melamine possible, see page 45). 100% PEFC and FSC.

19mm Melamin, Waagrecht Holz faser (8mm Melamin möglich, siehe Seite 45). 100% PEFC- und FSC-zertifiziert.



Noyer
Walnut wood
Nussbaum



H 3734



U 963



U 113

Hêtre
Beech
Buche

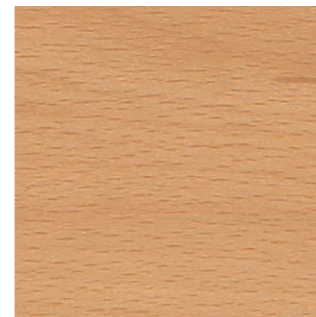

H 1582



U 732

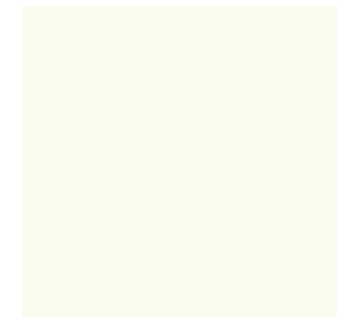

W 908

Erable
Maple
Ahorn



375 M



U 708

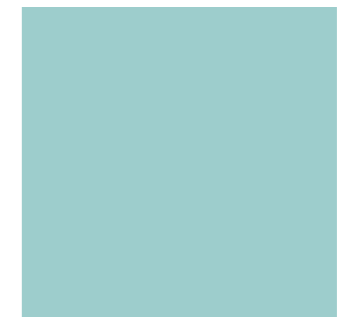

U 500

Pour un classement au feu M1 / B, s2, d0, d'autres mélaminés ou coloris, veuillez nous consulter.

Les photographies des mélaminés sont présentées à titre indicatif. Des variations de couleurs peuvent se produire. Nous vous conseillons de demander de vrais échantillons.

For B, s2, d0 fire safety classification, other melamine or colour finishes, please contact us.

The photographs of the melamine finishes are shown as a guideline only. Colours may vary. We recommend that you ask for samples before ordering.

Bei Fragen bezüglich der Brandschutzklasseneinstufung B, s2, d0, anderen Melaminbeschichtungen oder Farbtönen wenden Sie sich an uns.

Die Abbildungen der Melaminbeschichtungen sind unverbindlich. Es können Farbabweichungen auftreten. Wir empfehlen Ihnen, echte Probemuster anzufordern.

CLOISONNETTE MÉLAMINÉ

MELAMINE SCREEN

MELAMIN-STELLWAND

Kit de montage livré avec chaque cloisonnette
 Fitting set supplied with each screen
 Ein Bausatz versorgt mit jeder Stellwand

Hauteur Height Höhe	1200 mm	1400 mm	1600 mm	1800 mm			
Ref. MMM 1200 x 610	163 €	Ref. MMM 1400 x 610	170 €	Ref. MMM 1600 x 610	177 €	Ref. MMM 1800 x 610	187 €
Ref. MMM 1200 x 810	190 €	Ref. MMM 1400 x 810	198 €	Ref. MMM 1600 x 810	203 €	Ref. MMM 1800 x 810	215 €
Ref. MMM 1200 x 1010	224 €	Ref. MMM 1400 x 1010	227 €	Ref. MMM 1600 x 1010	232 €	Ref. MMM 1800 x 1010	244 €
Ref. MMM 1200 x 1210	249 €	Ref. MMM 1400 x 1210	258 €	Ref. MMM 1600 x 1210	264 €	Ref. MMM 1800 x 1210	275 €
Ref. MMM 1200 x 1410	285 €	Ref. MMM 1400 x 1410	293 €	Ref. MMM 1600 x 1410	298 €	Ref. MMM 1800 x 1410	311 €
Ref. MMM 1200 x 1610	321 €	Ref. MMM 1400 x 1610	331 €	Ref. MMM 1600 x 1610	335 €	Ref. MMM 1800 x 1610	348 €

Avec verre acrylique 3mm ou polycarbonate alvéolaire 6mm
 With 3mm acrylic glass or 6mm alveolar polycarbonate
 Mit 3mm Acrylglas oder 6mm Klarpolycarbonat

Ref. ___ 1200 x 610	172 €	Ref. ___ 1400 x 610	187 €	Ref. ___ 1600 x 610	202 €	Ref. ___ 1800 x 610	238 €
Ref. ___ 1200 x 810	202 €	Ref. ___ 1400 x 810	224 €	Ref. ___ 1600 x 810	245 €	Ref. ___ 1800 x 810	274 €
Ref. ___ 1200 x 1010	240 €	Ref. ___ 1400 x 1010	256 €	Ref. ___ 1600 x 1010	282 €	Ref. ___ 1800 x 1010	319 €
Ref. ___ 1200 x 1210	265 €	Ref. ___ 1400 x 1210	285 €	Ref. ___ 1600 x 1210	319 €	Ref. ___ 1800 x 1210	361 €
Ref. ___ 1200 x 1410	298 €	Ref. ___ 1400 x 1410	324 €	Ref. ___ 1600 x 1410	360 €	Ref. ___ 1800 x 1410	410 €
Ref. ___ 1200 x 1610	345 €	Ref. ___ 1400 x 1610	359 €	Ref. ___ 1600 x 1610	402 €	Ref. ___ 1800 x 1610	461 €



Ref. MMJ

Incolore
Colourless
Klar



Ref. MMG

Fumé gris
Gray tinted
Grau Rauch



Ref. MML

Opale
Opal
Opal



Ref. MMP

Polycarbonate alvéolaire incolore
Classement feu M1 / B, s1, d0
Clear alveolar polycarbonate
Fire safety classification B, s1, d0
Klarpolycarbonat
Feuersicherung Class B, s1, d0

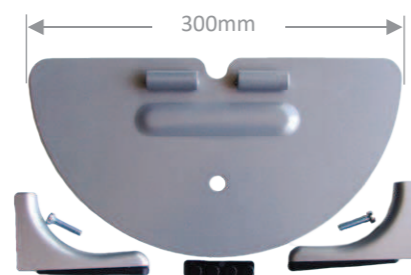

Ref. MVP 300 34 €
 Pied sur platine plate
 Prix unitaire
 Foot on flat plate
 Unit price
 Fuß auf flacher Platte
 Stückpreis

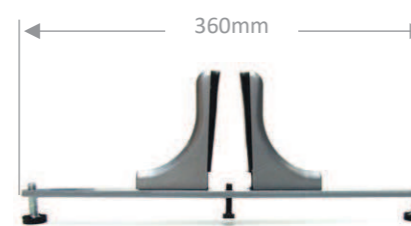

Ref. MVP 360 34 €
 Pied Réglable
 Prix unitaire
 Adjustable foot
 Unit price
 Verstellbarer Fuß
 Stückpreis

ÉCRAN DE BUREAU MÉLAMINÉ

MELAMINE DESK SCREEN

MELAMIN-TISCH-TRENNWAND





Hauteur Height Höhe	400 mm	600 mm	800 mm		
Ref. MMB 400 x 800	85 €	Ref. MMB 600 x 800	101 €	Ref. MMB 800 x 800	113 €
Ref. MMB 400 x 1000	96 €	Ref. MMB 600 x 1000	113 €	Ref. MMB 800 x 1000	128 €
Ref. MMB 400 x 1200	107 €	Ref. MMB 600 x 1200	128 €	Ref. MMB 800 x 1200	144 €
Ref. MMB 400 x 1400	117 €	Ref. MMB 600 x 1400	143 €	Ref. MMB 800 x 1400	161 €
Ref. MMB 400 x 1600	121 €	Ref. MMB 600 x 1600	148 €	Ref. MMB 800 x 1600	174 €
Ref. MMB 400 x 1800	135 €	Ref. MMB 600 x 1800	167 €	Ref. MMB 800 x 1800	198 €

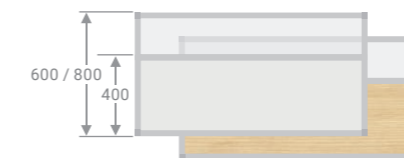

Avec verre acrylique incolore, fumé gris ou opale de 3mm ou polycarbonate alvéolaire de 6mm, à préciser à la commande
 With 3mm colourless, gray tinted or opal acrylic glass or 6mm alveolar polycarbonate, please specify when ordering
 Mit 3mm Klar, grau Rauch oder Opal Acrylglas oder 6mm Klarpolycarbonat, bitte bei Bestellung angeben

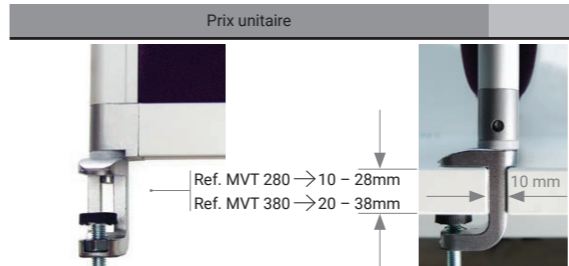

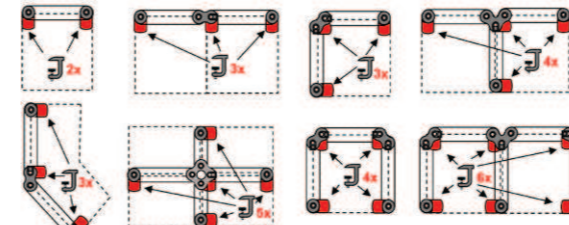

Ref. MMA 600 x 800	127 €	Ref. MMA 800 x 800	163 €
Ref. MMA 600 x 1000	150 €	Ref. MMA 800 x 1000	184 €
Ref. MMA 600 x 1200	155 €	Ref. MMA 800 x 1200	216 €
Ref. MMA 600 x 1400	190 €	Ref. MMA 800 x 1400	240 €
Ref. MMA 600 x 1600	207 €	Ref. MMA 800 x 1600	269 €
Ref. MMA 600 x 1800	232 €	Ref. MMA 800 x 1800	306 €

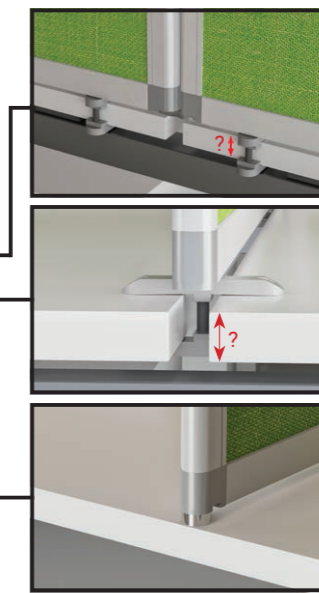
Prix unitaire	Unit price	Stückpreis
 <p>Ref. MVT 280 → 10 - 28mm Ref. MVT 380 → 20 - 38mm</p>		 <p>Ref. MVT 280 20 € Ref. MVT 380 20 €</p>
 <p>Position et quantité de pinces nécessaires selon l'implantation Clamps position and number required depending on the layout Klammern Positionen und Mengen erforderlich je nach Standort.</p>		 <p>Ref. MVU 280 24 € Ref. MVU 380 24 €</p>
<p>FIXATION POUR BUREAUX BENCH Veuillez préciser l'épaisseur du plateau</p>	<p>FIXING FOR BENCH DESKS Please specify the thickness of the desk surface</p>	<p>BEFESTIGUNG FÜR BENCH SCHREIBTISCHE Bitte geben Sie die Stärke der Tischplatte an</p>

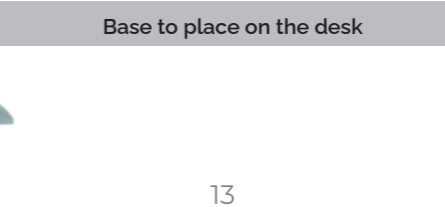

 <p>Ref. PBS 26 €</p>
 <p>Ref. PBD 28 €</p>
 <p>Ref. CYL 9 €</p>

Sabot à poser sur le bureau	Base to place on the desk	Sockel auf den Tisch zu lege
		 <p>Ref. MVZ 200 35 €</p>

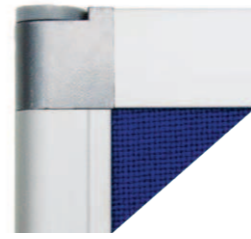

40% laine et 60% viscose

40% wool and 60% viscose

40% Wolle und 60% Viskose



A 204



A 243



A 220

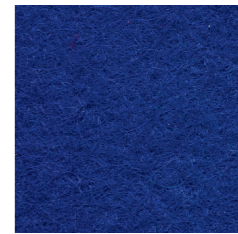

A 228



A 221



A 203

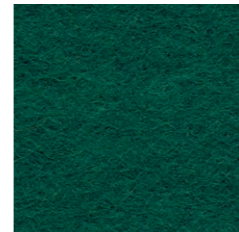

A 244



A 232



A 229



A 201

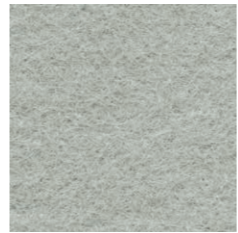

A 230

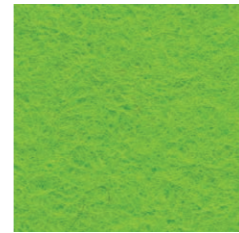

A 235

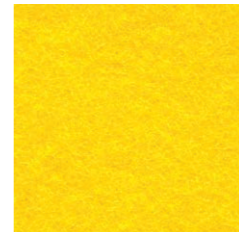

A 206

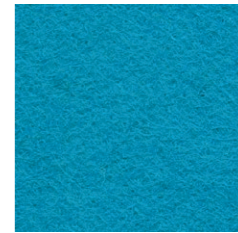

A 231

Moucheté

Speckled

Gesprenkelter

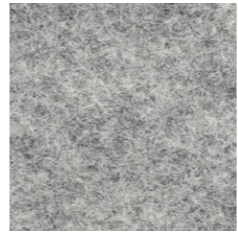

G 365



G 366



G 369

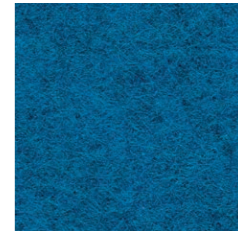

G 370



G 368

Pour d'autres gammes ou coloris, veuillez nous consulter.

Les photographies des tissus sont présentées à titre indicatif. Des variations de couleurs peuvent se produire. Nous vous conseillons de demander de vrais échantillons.

For other fabric range or colours, please contact us.

The photographs of the fabric finishes are shown as a guideline only. Colours may vary. We recommend that you ask for samples before ordering.

Andere Stoffe oder Farbe, kontaktieren Sie uns.

Die Abbildungen der Stoffbeschichtungen sind unverbindlich. Es können Farbabweichungen auftreten. Wir empfehlen Ihnen, echte Probenmuster anzufordern.

**TESTS
ACOUSTIQUES**

**ACOUSTIC
TESTS**

AKUSTIKTESTE

TISSU

FABRIC

STOFF



ACOUSTIQUE

ACOUSTIC



SUPER-ACOUSTIQUE

SUPER-ACOUSTIC

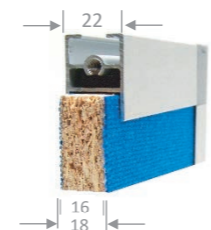

AKUSTIK

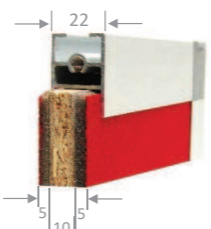

- 2 x 5mm de mousse + tissu
- 2 x 5mm foam + fabric
- 2 x 5mm Schaum + Stoff

SUPER-AKUSTIK

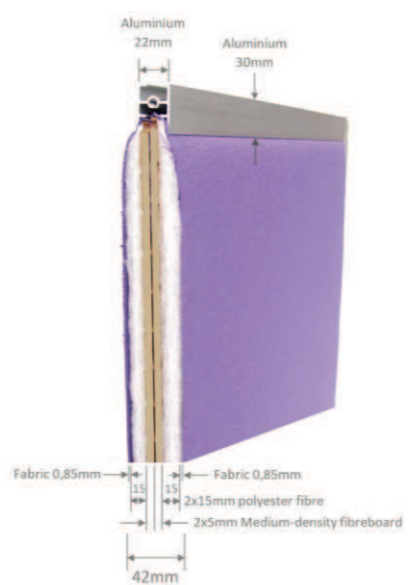

Le coefficient α_s exprime l'absorption de l'énergie sonore par la cloison de 0 à 1 (0 à 100%). Dans les bureaux, les fréquences se situent généralement entre 500 et 4000 Hertz (sons graves ou aigus). Le coefficient α_w exprime l'absorption acoustique pondérée.

The α_s coefficient is used to describe the partition's sound absorption on a scale from 0 to 1 (0 to 100%). In offices, these levels generally remain between 500 and 4000 Hertz (low- or high-pitched sounds). The α_w coefficient describes the weighted acoustic absorption.

Der Koeffizient α_s gibt die von der Trennwand absorbierte Schallenergie von 0 bis 1 (0 bis 100%) an. In Büros liegen die Frequenzen in der Regel zwischen 500 und 4000 Hertz (tiefe oder hohe Töne). Der Koeffizient α_w gibt den gewichteten Schallabsorptionsgrad an.

	Mélaminé	Tissu	Acoustique	Super-Acoustique
	Melamine	Fabric	Acoustic	Super-Acoustic
	Melamin	Stoff	Akustik	Super-Akustik
α_w	0,05(I)	0,1(I)	0,15(H)	0,45(H)
Frequency (Hz)	α_s			
100	0,00	0,00	0,00	0,13
125	0,00	0,01	0,00	0,19
160	0,02	0,00	0,04	0,22
200	0,00	0,00	0,04	0,26
250	0,03	0,05	0,07	0,30
315	0,02	0,04	0,05	0,28
400	0,02	0,03	0,04	0,32
500	0,01	0,02	0,05	0,36
630	0,03	0,04	0,08	0,41
800	0,02	0,04	0,12	0,45
1000	0,03	0,05	0,14	0,52
1250	0,04	0,08	0,16	0,60
1600	0,03	0,09	0,21	0,70
2000	0,04	0,08	0,24	0,79
2500	0,05	0,10	0,31	0,87
3150	0,04	0,09	0,38	0,91
4000	0,08	0,11	0,44	0,94
5000	0,20	0,21	0,53	0,96

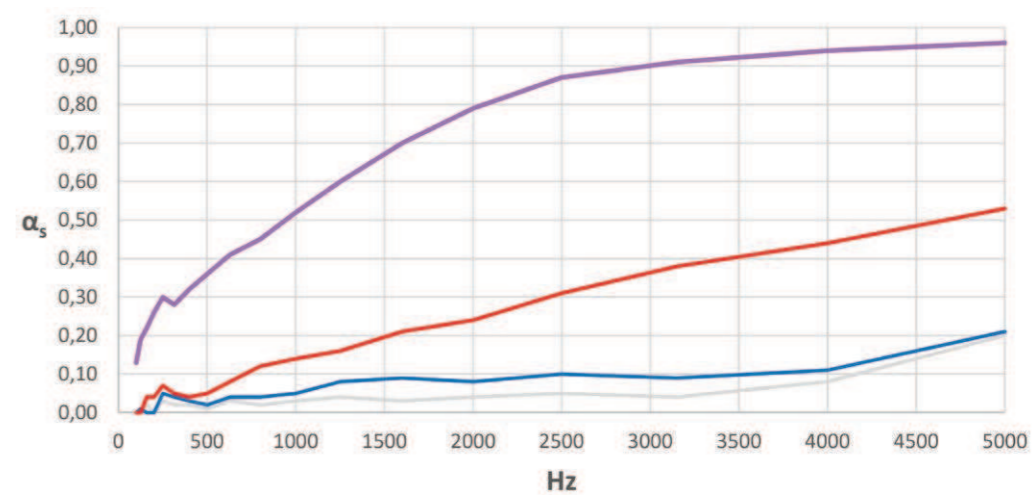
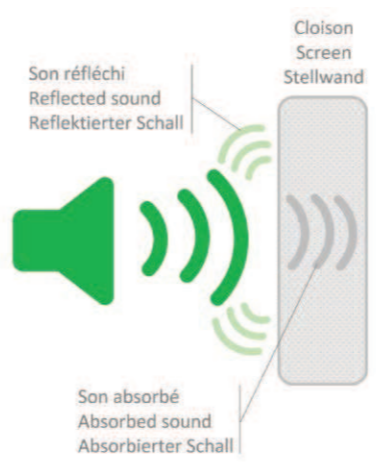

Solutions Acoustiques page 42

Acoustic Solutions page 42

Akustische Lösungen Seite 42

 **CLOISONNETTE
TISSU**

 **FABRIC
SCREEN**

 **STOFF-
STELLWAND**

 **ÉCRAN DE BUREAU
TISSU**

 **FABRIC
DESK SCREEN**

 **STOFF-
TISCH-TRENNWAND**

 Kit de montage livré avec chaque cloisonnette
Fitting set supplied with each screen
Ein Bausatz versorgt mit jeder Stellwand

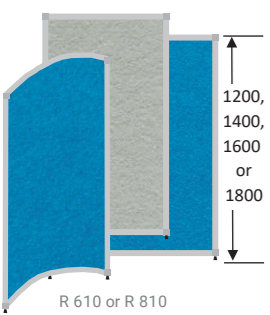

Hauteur Height Höhe	1200 mm	1400 mm	1600 mm	1800 mm			
Ref. MTT 1200 x 610	187 €	Ref. MTT 1400 x 610	199 €	Ref. MTT 1600 x 610	209 €	Ref. MTT 1800 x 610	239 €
Ref. MTT 1200 x 810	204 €	Ref. MTT 1400 x 810	225 €	Ref. MTT 1600 x 810	240 €	Ref. MTT 1800 x 810	282 €
Ref. MTT 1200 x 1010	265 €	Ref. MTT 1400 x 1010	280 €	Ref. MTT 1600 x 1010	285 €	Ref. MTT 1800 x 1010	379 €
Ref. MTT 1200 x 1210	299 €	Ref. MTT 1400 x 1210	313 €	Ref. MTT 1600 x 1210	322 €	Ref. MTT 1800 x 1210	397 €
Ref. MTT 1200 x 1410	335 €	Ref. MTT 1400 x 1410	345 €	Ref. MTT 1600 x 1410	361 €	Ref. MTT 1800 x 1410	419 €
Ref. MTT 1200 x 1610	345 €	Ref. MTT 1400 x 1610	360 €	Ref. MTT 1600 x 1610	395 €	Ref. MTT 1800 x 1610	443 €
Ref. MTT 1200 x R610	599 €	Ref. MTT 1400 x R610	629 €	Ref. MTT 1600 x R610	659 €	Ref. MTT 1800 x R610	729 €
Ref. MTT 1200 x R810	649 €	Ref. MTT 1400 x R810	679 €	Ref. MTT 1600 x R810	729 €	Ref. MTT 1800 x R810	779 €

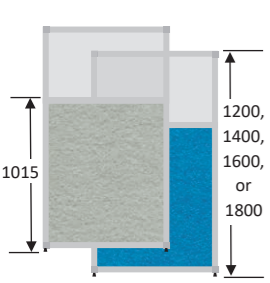

Avec verre acrylique 3mm ou polycarbonate alvéolaire 6mm
With 3mm acrylic glass or 6mm alveolar polycarbonate
Mit 3mm Acrylglas oder 6mm Klarpolycarbonat

Ref.	Price	Ref.	Price	Ref.	Price	Ref.	Price
1200 x 610	228 €	1400 x 610	248 €	1600 x 610	264 €	1800 x 610	320 €
1200 x 810	248 €	1400 x 810	279 €	1600 x 810	319 €	1800 x 810	357 €
1200 x 1010	331 €	1400 x 1010	361 €	1600 x 1010	408 €	1800 x 1010	457 €
1200 x 1210	359 €	1400 x 1210	397 €	1600 x 1210	442 €	1800 x 1210	505 €
1200 x 1410	381 €	1400 x 1410	433 €	1600 x 1410	482 €	1800 x 1410	558 €
1200 x 1610	397 €	1400 x 1610	465 €	1600 x 1610	518 €	1800 x 1610	597 €

 Ref. MTJ	 Ref. MTG	 Ref. MTL	 Ref. MTP
Incolore	Fumé gris	Opale	Polycarbonate alvéolaire incolore Classement feu M1 / B, s1, d0
Colourless	Gray tinted	Opal	Clear alveolar polycarbonate Fire safety classification B, s1, d0
Klar	Grau Rauch	Opal	Klarpolycarbonat Feuersicherung Class B, s1, d0

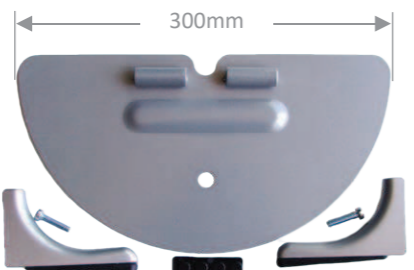

Ref. MVP 300 **34 €**
Pied sur platine plate
Prix unitaire
Foot on flat plate
Unit price
Fuß auf flacher Platte
Stückpreis

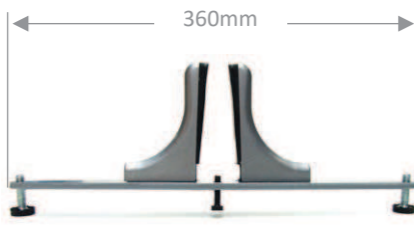

Ref. MVP 360 **34 €**
Pied Réglable
Prix unitaire
Adjustable foot
Unit price
Verstellbarer Fuß
Stückpreis

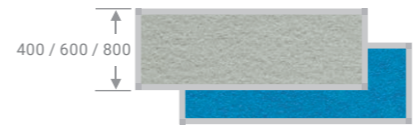





Hauteur Height Höhe	400 mm	600 mm	800 mm		
Ref. MTB 400 x 800	104 €	Ref. MTB 600 x 800	128 €	Ref. MTB 800 x 800	143 €
Ref. MTB 400 x 1000	131 €	Ref. MTB 600 x 1000	155 €	Ref. MTB 800 x 1000	163 €
Ref. MTB 400 x 1200	143 €	Ref. MTB 600 x 1200	186 €	Ref. MTB 800 x 1200	184 €
Ref. MTB 400 x 1400	153 €	Ref. MTB 600 x 1400	190 €	Ref. MTB 800 x 1400	207 €
Ref. MTB 400 x 1600	155 €	Ref. MTB 600 x 1600	192 €	Ref. MTB 800 x 1600	224 €
Ref. MTB 400 x 1800	175 €	Ref. MTB 600 x 1800	216 €	Ref. MTB 800 x 1800	248 €

Avec verre acrylique incolore, fumé gris ou opale de 3mm ou polycarbonate alvéolaire de 6mm, à préciser à la commande
With 3mm colourless, gray tinted or opal acrylic glass or 6mm alveolar polycarbonate, please specify when ordering
Mit 3mm Klar, grau Rauch oder Opal Acrylglas oder 6mm Klarpolycarbonat, bitte bei Bestellung angeben

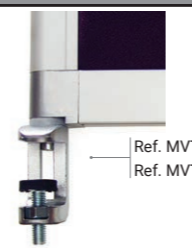
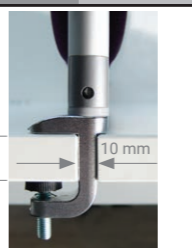

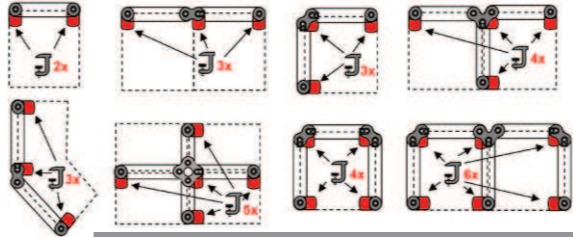
Ref. MTA 600 x 800	162 €	Ref. MTA 800 x 800	203 €
Ref. MTA 600 x 1000	195 €	Ref. MTA 800 x 1000	236 €
Ref. MTA 600 x 1200	215 €	Ref. MTA 800 x 1200	276 €
Ref. MTA 600 x 1400	247 €	Ref. MTA 800 x 1400	308 €
Ref. MTA 600 x 1600	263 €	Ref. MTA 800 x 1600	335 €
Ref. MTA 600 x 1800	291 €	Ref. MTA 800 x 1800	373 €

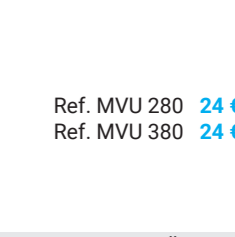
Prix unitaire	Unit price	Stückpreis
	Ref. MVT 280 → 10 - 28mm	Ref. MVT 280 20 €
	Ref. MVT 380 → 20 - 38mm	Ref. MVT 380 20 €
		
		
	Position et quantité de pinces nécessaires selon l'implantation Clamps position and number required depending on the layout Klammern Positionen und Mengen erforderlich je nach Standort.	
	FIXATION POUR BUREAU BENCH Veuillez préciser l'épaisseur du plateau	Ref. MVU 280 24 € Ref. MVU 380 24 €
	FIXING FOR BENCH DESKS Please specify the thickness of the desk surface	
	BEFESTIGUNG FÜR BENCH SCHREIBTISCHE Bitte geben Sie die Stärke der Tischplatte an	

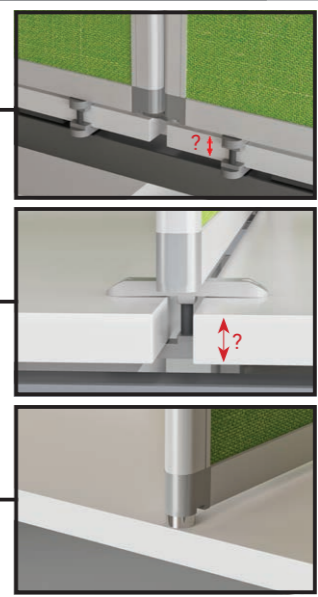

	Ref. PBS 26 €
	Ref. PBD 28 €
	Ref. CYL 9 €

Sabot à poser sur le bureau Base to place on the desk Sockel auf den Tisch zu lege

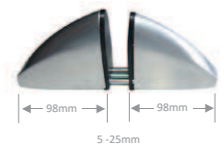

Ref. MVZ 200 **35 €**

**CLOISONNETTE
ACOUSTIQUE**

**ACOUSTIC
SCREEN**

**AKUSTIK-
STELLWAND**



Kit de montage livré avec chaque cloisonnette

Fitting set supplied with each screen

Ein Bausatz versorgt mit jeder Stellwand

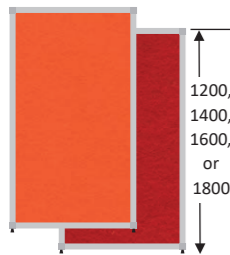

Hauteur Height Höhe	1200 mm	1400 mm	1600 mm	1800 mm
	Ref. FTT 1200 x 610 224 €	Ref. FTT 1400 x 610 238 €	Ref. FTT 1600 x 610 249 €	Ref. FTT 1800 x 610 289 €
	Ref. FTT 1200 x 810 248 €	Ref. FTT 1400 x 810 265 €	Ref. FTT 1600 x 810 285 €	Ref. FTT 1800 x 810 332 €
	Ref. FTT 1200 x 1010 313 €	Ref. FTT 1400 x 1010 321 €	Ref. FTT 1600 x 1010 329 €	Ref. FTT 1800 x 1010 445 €
	Ref. FTT 1200 x 1210 356 €	Ref. FTT 1400 x 1210 365 €	Ref. FTT 1600 x 1210 373 €	Ref. FTT 1800 x 1210 460 €
	Ref. FTT 1200 x 1410 397 €	Ref. FTT 1400 x 1410 405 €	Ref. FTT 1600 x 1410 424 €	Ref. FTT 1800 x 1410 469 €
	Ref. FTT 1200 x 1610 419 €	Ref. FTT 1400 x 1610 434 €	Ref. FTT 1600 x 1610 469 €	Ref. FTT 1800 x 1610 482 €

Avec verre acrylique 3mm ou polycarbonate alvéolaire 6mm
With 3mm acrylic glass or 6mm alveolar polycarbonate
Mit 3mm Acrylglas oder 6mm Klarpolycarbonat

Ref. _____ 1200 x 610 261 €	Ref. _____ 1400 x 610 288 €	Ref. _____ 1600 x 610 298 €	Ref. _____ 1800 x 610 347 €
Ref. _____ 1200 x 810 324 €	Ref. _____ 1400 x 810 312 €	Ref. _____ 1600 x 810 385 €	Ref. _____ 1800 x 810 421 €
Ref. _____ 1200 x 1010 379 €	Ref. _____ 1400 x 1010 417 €	Ref. _____ 1600 x 1010 457 €	Ref. _____ 1800 x 1010 517 €
Ref. _____ 1200 x 1210 408 €	Ref. _____ 1400 x 1210 454 €	Ref. _____ 1600 x 1210 494 €	Ref. _____ 1800 x 1210 565 €
Ref. _____ 1200 x 1410 434 €	Ref. _____ 1400 x 1410 489 €	Ref. _____ 1600 x 1410 540 €	Ref. _____ 1800 x 1410 621 €
Ref. _____ 1200 x 1610 456 €	Ref. _____ 1400 x 1610 522 €	Ref. _____ 1600 x 1610 594 €	Ref. _____ 1800 x 1610 677 €



Ref. FTJ	Ref. FTG	Ref. FTL	Ref. FTP
Incolore	Fumé gris	Opale	Polycarbonate alvéolaire incolore Classement feu M1 / B, s1, d0
Colourless	Gray tinted	Opal	Clear alveolar polycarbonate Fire safety classification B, s1, d0
Klar	Grau Rauch	Opal	Klarpolycarbonat Feuersicherung Class B, s1, d0

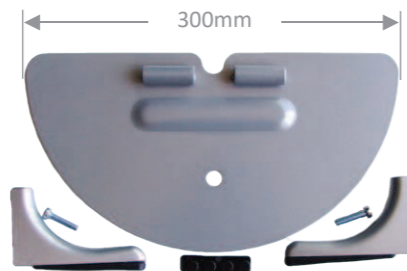

Ref. MVP 300 **34 €**
Pied sur platine plate
Prix unitaire
Foot on flat plate
Unit price
Fuß auf flacher Platte
Stückpreis

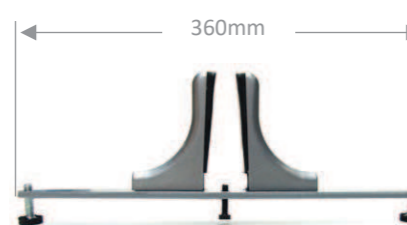

Ref. MVP 360 **34 €**
Pied Réglable
Prix unitaire
Adjustable foot
Unit price
Verstellbarer Fuß
Stückpreis

**ÉCRAN DE BUREAU
ACOUSTIQUE**

**ACOUSTIC
DESK SCREEN**

**AKUSTIK-
TISCH-TRENNWAND**

Hauteur Height Höhe	400 mm	600 mm	800 mm
	Ref. FPB 400 x 800 119 €	Ref. FPB 600 x 800 146 €	Ref. FPB 800 x 800 155 €
	Ref. FPB 400 x 1000 153 €	Ref. FPB 600 x 1000 179 €	Ref. FPB 800 x 1000 180 €
	Ref. FPB 400 x 1200 164 €	Ref. FPB 600 x 1200 210 €	Ref. FPB 800 x 1200 204 €
	Ref. FPB 400 x 1400 176 €	Ref. FPB 600 x 1400 216 €	Ref. FPB 800 x 1400 233 €
	Ref. FPB 400 x 1600 180 €	Ref. FPB 600 x 1600 225 €	Ref. FPB 800 x 1600 252 €
	Ref. FPB 400 x 1800 212 €	Ref. FPB 600 x 1800 269 €	Ref. FPB 800 x 1800 287 €



Avec verre acrylique incolore, fumé gris ou opale de 3mm ou polycarbonate alvéolaire de 6mm, à préciser à la commande
With 3mm colourless, gray tinted or opal acrylic glass or 6mm alveolar polycarbonate, please specify when ordering
Mit 3mm Klar, grau Rauch oder Opal Acrylglas oder 6mm Klarpolycarbonat, bitte bei Bestellung angeben



Ref. FPA 600 x 800 190 €	Ref. FPA 800 x 800 234 €
Ref. FPA 600 x 1000 225 €	Ref. FPA 800 x 1000 268 €
Ref. FPA 600 x 1200 249 €	Ref. FPA 800 x 1200 313 €
Ref. FPA 600 x 1400 284 €	Ref. FPA 800 x 1400 349 €
Ref. FPA 600 x 1600 299 €	Ref. FPA 800 x 1600 377 €
Ref. FPA 600 x 1800 353 €	Ref. FPA 800 x 1800 442 €

Prix unitaire	Unit price	Stückpreis
<p>Ref. MVT 280 → 10 - 28mm Ref. MVT 380 → 20 - 38mm</p>		<p>Ref. MVT 280 20 € Ref. MVT 380 20 €</p>
<p>Position et quantité de pinces nécessaires selon l'implantation Clamps position and number required depending on the layout Klammern Positionen und Mengen erforderlich je nach Standort.</p>		<p>Ref. MVU 280 24 € Ref. MVU 380 24 €</p>
<p>FIXATION POUR BUREAU BENCH Veuillez préciser l'épaisseur du plateau</p>	<p>FIXING FOR BENCH DESKS Please specify the thickness of the desk surface</p>	<p>BEFESTIGUNG FÜR BENCH SCHREIBTISCHE Bitte geben Sie die Stärke der Tischplatte an</p>

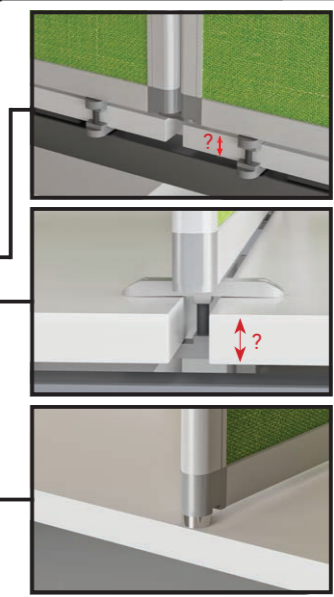

Sabot à poser sur le bureau Base to place on the desk Sockel auf den Tisch zu lege

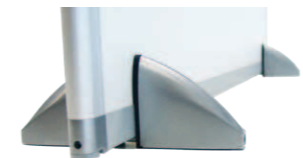

Ref. MVZ 200 **35 €**

**CLOISONNETTE
SUPER-ACOUSTIQUE**

**SUPER-ACOUSTIC
SCREEN**

**SUPER AKUSTIK-
STELLWAND**



Kit de montage livré avec chaque cloisonnette

Fitting set supplied with each screen

Ein Bausatz versorgt mit jeder Stellwand

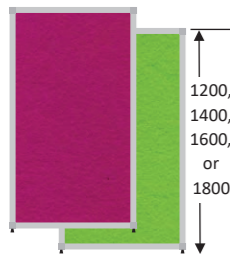

Hauteur Height Höhe	1200 mm	1400 mm	1600 mm	1800 mm			
Ref. ATT 1200 x 610	297 €	Ref. ATT 1400 x 610	324 €	Ref. ATT 1600 x 610	349 €	Ref. ATT 1800 x 610	361 €
Ref. ATT 1200 x 810	355 €	Ref. ATT 1400 x 810	421 €	Ref. ATT 1600 x 810	432 €	Ref. ATT 1800 x 810	481 €
Ref. ATT 1200 x 1010	413 €	Ref. ATT 1400 x 1010	452 €	Ref. ATT 1600 x 1010	462 €	Ref. ATT 1800 x 1010	564 €
Ref. ATT 1200 x 1210	438 €	Ref. ATT 1400 x 1210	482 €	Ref. ATT 1600 x 1210	505 €	Ref. ATT 1800 x 1210	579 €
Ref. ATT 1200 x 1410	465 €	Ref. ATT 1400 x 1410	518 €	Ref. ATT 1600 x 1410	569 €	Ref. ATT 1800 x 1410	590 €
Ref. ATT 1200 x 1610	482 €	Ref. ATT 1400 x 1610	554 €	Ref. ATT 1600 x 1610	590 €	Ref. ATT 1800 x 1610	603 €

Avec verre acrylique 3mm ou polycarbonate alvéolaire 6mm
With 3mm acrylic glass or 6mm alveolar polycarbonate
Mit 3mm Acrylglas oder 6mm Klarpolycarbonat

Ref. ___ 1200 x 610	324 €	Ref. ___ 1400 x 610	352 €	Ref. ___ 1600 x 610	373 €	Ref. ___ 1800 x 610	401 €
Ref. ___ 1200 x 810	376 €	Ref. ___ 1400 x 810	448 €	Ref. ___ 1600 x 810	456 €	Ref. ___ 1800 x 810	482 €
Ref. ___ 1200 x 1010	452 €	Ref. ___ 1400 x 1010	499 €	Ref. ___ 1600 x 1010	541 €	Ref. ___ 1800 x 1010	602 €
Ref. ___ 1200 x 1210	465 €	Ref. ___ 1400 x 1210	524 €	Ref. ___ 1600 x 1210	629 €	Ref. ___ 1800 x 1210	655 €
Ref. ___ 1200 x 1410	482 €	Ref. ___ 1400 x 1410	579 €	Ref. ___ 1600 x 1410	649 €	Ref. ___ 1800 x 1410	691 €
Ref. ___ 1200 x 1610	603 €	Ref. ___ 1400 x 1610	655 €	Ref. ___ 1600 x 1610	692 €	Ref. ___ 1800 x 1610	723 €



Ref. ATJ	Ref. ATG	Ref. ATL	Ref. ATP
Incolore	Fumé gris	Opale	Polycarbonate alvéolaire incolore Classement feu M1 / B, s1, d0
Colourless	Gray tinted	Opal	Clear alveolar polycarbonate Fire safety classification B, s1, d0
Klar	Grau Rauch	Opal	Klarpolycarbonat Feuersicherung Class B, s1, d0

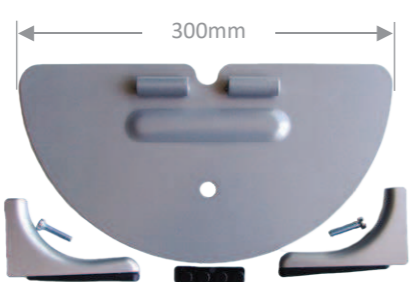

Ref. MVP 300 **34 €**
Pied sur platine plate
Prix unitaire
Foot on flat plate
Unit price
Fuß auf flacher Platte
Stückpreis

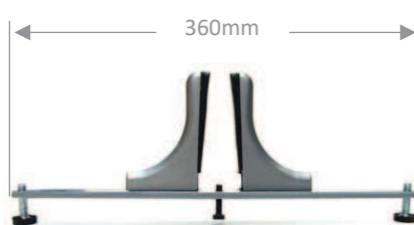

Ref. MVP 360 **34 €**
Pied Réglable
Prix unitaire
Adjustable foot
Unit price
Verstellbarer Fuß
Stückpreis

**ÉCRAN DE BUREAU
SUPER-ACOUSTIQUE**

**SUPER-ACOUSTIC
DESK SCREEN**

**SUPER AKUSTIK-
TISCH-TRENNWAND**

Hauteur Height Höhe	400 mm	600 mm	800 mm		
Ref. ATB 400 x 800	159 €	Ref. ATB 600 x 800	189 €	Ref. ATB 800 x 800	232 €
Ref. ATB 400 x 1000	177 €	Ref. ATB 600 x 1000	228 €	Ref. ATB 800 x 1000	249 €
Ref. ATB 400 x 1200	211 €	Ref. ATB 600 x 1200	250 €	Ref. ATB 800 x 1200	266 €
Ref. ATB 400 x 1400	218 €	Ref. ATB 600 x 1400	299 €	Ref. ATB 800 x 1400	299 €
Ref. ATB 400 x 1600	228 €	Ref. ATB 600 x 1600	313 €	Ref. ATB 800 x 1600	313 €
Ref. ATB 400 x 1800	240 €	Ref. ATB 600 x 1800	360 €	Ref. ATB 800 x 1800	433 €



Avec verre acrylique incolore, fumé gris ou opale de 3mm ou polycarbonate alvéolaire de 6mm, à préciser à la commande
With 3mm colourless, gray tinted or opal acrylic glass or 6mm alveolar polycarbonate, please specify when ordering
Mit 3mm Klar, grau Rauch oder Opal Acrylglas oder 6mm Klarpolycarbonat, bitte bei Bestellung angeben



Ref. ATA 600 x 800	195 €	Ref. ATA 800 x 800	240 €
Ref. ATA 600 x 1000	232 €	Ref. ATA 800 x 1000	276 €
Ref. ATA 600 x 1200	252 €	Ref. ATA 800 x 1200	323 €
Ref. ATA 600 x 1400	296 €	Ref. ATA 800 x 1400	361 €
Ref. ATA 600 x 1600	319 €	Ref. ATA 800 x 1600	397 €
Ref. ATA 600 x 1800	353 €	Ref. ATA 800 x 1800	443 €

Prix unitaire	Unit price	Stückpreis
<p>Ref. MVT 280 → 10 - 28mm Ref. MVT 380 → 20 - 38mm</p>		<p>Ref. MVT 280 20 € Ref. MVT 380 20 €</p>
<p>Position et quantité de pinces nécessaires selon l'implantation Clamps position and number required depending on the layout Klammern Positionen und Mengen erforderlich je nach Standort.</p>		<p>Ref. MVU 280 24 € Ref. MVU 380 24 €</p>
<p>FIXATION POUR BUREAUX BENCH Veuillez préciser l'épaisseur du plateau</p>	<p>FIXING FOR BENCH DESKS Please specify the thickness of the desk surface</p>	<p>BEFESTIGUNG FÜR BENCH SCHREIBTISCHE Bitte geben Sie die Stärke der Tischplatte an</p>



Sabot à poser sur le bureau

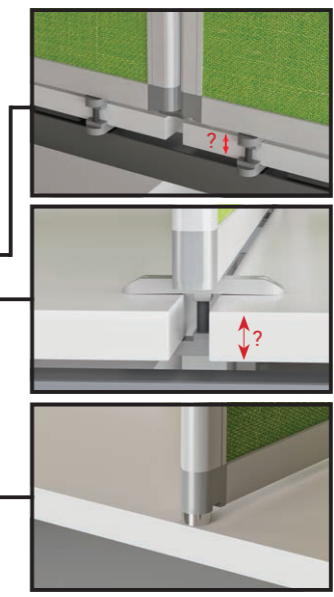

Base to place on the desk



Sockel auf den Tisch zu lege



Ref. MVZ 200 **35 €**

 **VERRE ACRYLIQUE
+ POLYCARBONATE**

 **ACRYLIC GLASS +
POLYCARBONATE**

 **ACRYLGLAS +
POLYCARBONAT**



Store
pour cloisonnettes en verre acrylique

Venetian blind
for acrylic glass screens

Jalousie
für Acrylglas Stellwände

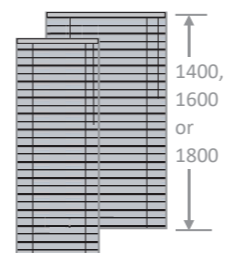

Hauteur
Height
Höhe

1400 mm

1600 mm

1800 mm

Ref. MVV 1400 x 610 **146 €**
Ref. MVV 1400 x 810 **148 €**
Ref. MVV 1400 x 1010 **175 €**
Ref. MVV 1400 x 1210 **215 €**

Ref. MVV 1600 x 610 **151 €**
Ref. MVV 1600 x 810 **159 €**
Ref. MVV 1600 x 1010 **198 €**
Ref. MVV 1600 x 1210 **239 €**

Ref. MVV 1800 x 610 **161 €**
Ref. MVV 1800 x 810 **177 €**
Ref. MVV 1800 x 1010 **224 €**
Ref. MVV 1800 x 1210 **273 €**

**CLOISONNETTE
VERRE ACRYLIQUE
+ POLYCARBONATE**

**ACRYLIC GLASS +
POLYCARBONATE
SCREEN**

**ACRYLGLAS +
POLYCARBONAT
STELLWAND**

**ÉCRAN DE BUREAU
VERRE ACRYLIQUE
+ POLYCARBONATE**

**ACRYLIC GLASS +
POLYCARBONATE
DESK SCREEN**

**ACRYLGLAS +
POLYCARBONAT
TISCH-TRENNWAND**



Kit de montage livré avec chaque cloisonnette

Fitting set supplied with each screen

Ein Bausatz versorgt mit jeder Stellwand

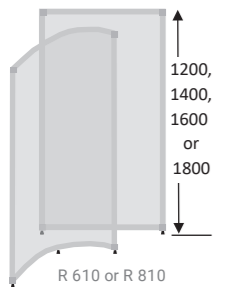

Hauteur Height Höhe	1200 mm	1400 mm	1600 mm	1800 mm			
Ref. _____ 1200 x 610	225 €	Ref. _____ 1400 x 610	252 €	Ref. _____ 1600 x 610	269 €	Ref. _____ 1800 x 610	306 €
Ref. _____ 1200 x 810	276 €	Ref. _____ 1400 x 810	299 €	Ref. _____ 1600 x 810	324 €	Ref. _____ 1800 x 810	368 €
Ref. _____ 1200 x 1010	329 €	Ref. _____ 1400 x 1010	349 €	Ref. _____ 1600 x 1010	381 €	Ref. _____ 1800 x 1010	428 €
Ref. _____ 1200 x 1210	361 €	Ref. _____ 1400 x 1210	394 €	Ref. _____ 1600 x 1210	437 €	Ref. _____ 1800 x 1210	494 €
Ref. _____ 1200 x R610	669 €	Ref. _____ 1400 x R610	689 €	Ref. _____ 1600 x R610	739 €	Ref. _____ 1800 x R610	759 €
Ref. _____ 1200 x R810	819 €	Ref. _____ 1400 x R810	829 €	Ref. _____ 1600 x R810	849 €	Ref. _____ 1800 x R810	869 €



Ref. MAJ

Incolore
Colourless
Klar



Ref. MAG

Fumé gris
Gray tinted
Grau Rauch



Ref. MAL

Opale
Opal
Opal



Polycarbonate alvéolaire incolore
Classement feu M1 / B, s1, d0
Clear alveolar polycarbonate
Fire safety classification B, s1, d0
Klarpolycarbonat
Feuersicherung Class B, s1, d0

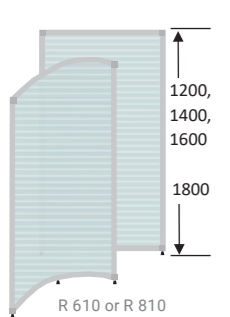

Avec polycarbonate alvéolaire 6mm
With 6mm alveolar polycarbonate
Mit 6mm Klarpolycarbonat

Ref. MAP 1200 x 610	225 €	Ref. MAP 1400 x 610	252 €	Ref. MAP 1600 x 610	269 €	Ref. MAP 1800 x 610	306 €
Ref. MAP 1200 x 810	276 €	Ref. MAP 1400 x 810	299 €	Ref. MAP 1600 x 810	324 €	Ref. MAP 1800 x 810	368 €
Ref. MAP 1200 x 1010	329 €	Ref. MAP 1400 x 1010	349 €	Ref. MAP 1600 x 1010	381 €	Ref. MAP 1800 x 1010	428 €
Ref. MAP 1200 x 1210	361 €	Ref. MAP 1400 x 1210	394 €	Ref. MAP 1600 x 1210	437 €	Ref. MAP 1800 x 1210	494 €
Ref. MAP 1200 x 1410	457 €	Ref. MAP 1400 x 1410	469 €	Ref. MAP 1600 x 1410	508 €	Ref. MAP 1800 x 1410	579 €
Ref. MAP 1200 x 1610	482 €	Ref. MAP 1400 x 1610	506 €	Ref. MAP 1600 x 1610	554 €	Ref. MAP 1800 x 1610	627 €
Ref. MAP 1200 x R810	819 €	Ref. MAP 1400 x R810	829 €	Ref. MAP 1600 x R810	849 €		

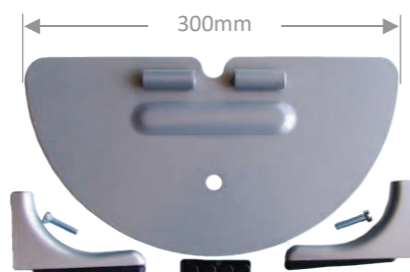

Ref. MVP 300 34 €

Pied sur platine plate
Prix unitaire

Foot on flat plate
Unit price

Fuß auf flacher Platte
Stückpreis

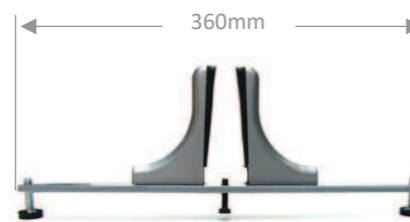

Ref. MVP 360 34 €

Pied Réglable
Prix unitaire

Adjustable foot
Unit price

Verstellbarer Fuß
Stückpreis

Avec verre acrylique incolore, fumé gris ou opale de 3mm ou polycarbonate alvéolaire de 6mm, à préciser à la commande
With 3mm colourless, gray tinted or opal acrylic glass or 6mm alveolar polycarbonate, please specify when ordering
Mit 3mm Klar, grau Rauch oder Opal Acrylglas oder 6mm Klarpolycarbonat, bitte bei Bestellung angeben

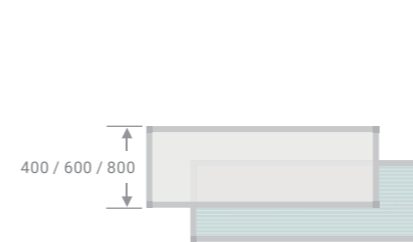

Hauteur Height Höhe	400 mm	600 mm	800 mm		
Ref. MVA 400 x 800	123 €	Ref. MVA 600 x 800	154 €	Ref. MVA 800 x 800	187 €
Ref. MVA 400 x 1000	148 €	Ref. MVA 600 x 1000	179 €	Ref. MVA 800 x 1000	219 €
Ref. MVA 400 x 1200	164 €	Ref. MVA 600 x 1200	203 €	Ref. MVA 800 x 1200	251 €
Ref. MVA 400 x 1400	184 €	Ref. MVA 600 x 1400	238 €	Ref. MVA 800 x 1400	287 €
Ref. MVA 400 x 1600	202 €	Ref. MVA 600 x 1600	256 €	Ref. MVA 800 x 1600	311 €
Ref. MVA 400 x 1800	228 €	Ref. MVA 600 x 1800	289 €	Ref. MVA 800 x 1800	353 €

Prix unitaire	Unit price	Stückpreis
<p>Ref. MVT 280 → 10 - 28mm Ref. MVT 380 → 20 - 38mm</p>		<p>Ref. MVT 280 20 € Ref. MVT 380 20 €</p>
		<p>Ref. MVU 280 24 € Ref. MVU 380 24 €</p>
<p>Position et quantité de pinces nécessaires selon l'implantation Clamps position and number required depending on the layout Klammern Positionen und Mengen erforderlich je nach Standort.</p>	<p>FIXATION POUR BUREAUX BENCH Veuillez préciser l'épaisseur du plateau</p>	<p>FIXING FOR BENCH DESKS Please specify the thickness of the desk surface</p>
		<p>BEFESTIGUNG FÜR BENCH SCHREIBTISCHE Bitte geben Sie die Stärke der Tischplatte an</p>

	Ref. PBS 26 €
	Ref. PBD 28 €
	Ref. CYL 9 €

Sabot à poser sur le bureau Base to place on the desk Sockel auf den Tisch zu lege



Ref. MVZ 200 35 €

PANNEAUX D’AFFICHAGE MAGNÉTIQUES

MAGNETIC NOTICE BOARDS

MAGNETISCHE ANSCHLAGTAFELN

ÉCRAN DE BUREAU MAGNÉTIQUE

MAGNETIC DESK SCREEN

MAGNETISCH TISCH-TRENNWAND

 Kit de montage livré avec chaque cloisonnette
 Fitting set supplied with each screen
 Ein Bausatz versorgt mit jeder Stellwand

Hauteur Height Höhe	1400 mm	1600 mm	1800 mm
1 face magnétique émaillée écrivable + 1 face mélaminé blanc			
1 enamelled magnetic writable side + 1 side white melamine			
1 emailiert magnetisch und beschreibbar Seite + 1 weiße melaminierte Seite			

Ref. TMM 1400 x 610 265 €	Ref. TMM 1600 x 610 287 €	Ref. TMM 1800 x 610 328 €
Ref. TMM 1400 x 810 389 €	Ref. TMM 1600 x 810 434 €	Ref. TMM 1800 x 810 489 €
Ref. TMM 1400 x 1010 421 €	Ref. TMM 1600 x 1010 466 €	Ref. TMM 1800 x 1010 524 €
Ref. TMM 1400 x 1210 445 €	Ref. TMM 1600 x 1210 494 €	Ref. TMM 1800 x 1210 554 €

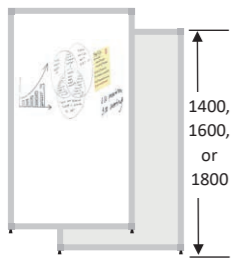

1 face magnétique émaillée écrivable + 1 face tissu		
1 enamelled magnetic writable side + 1 side fabric		
1 emailiert magnetisch und beschreibbar Seite + 1 Seite Stoff		

Ref. TTT 1400 x 610 279 €	Ref. TTT 1600 x 610 299 €	Ref. TTT 1800 x 610 343 €
Ref. TTT 1400 x 810 412 €	Ref. TTT 1600 x 810 453 €	Ref. TTT 1800 x 810 482 €
Ref. TTT 1400 x 1010 445 €	Ref. TTT 1600 x 1010 486 €	Ref. TTT 1800 x 1010 574 €
Ref. TTT 1400 x 1210 476 €	Ref. TTT 1600 x 1210 515 €	Ref. TTT 1800 x 1210 590 €

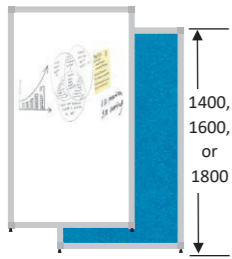

2 faces magnétiques émaillées écrivables		
2 enamelled magnetic writable sides		
2 emailiert magnetisch und beschreibbar Seiten		

Ref. TEX 1400 x 610 354 €	Ref. TEX 1600 x 610 393 €	Ref. TEX 1800 x 610 445 €
Ref. TEX 1400 x 810 590 €	Ref. TEX 1600 x 810 663 €	Ref. TEX 1800 x 810 723 €
Ref. TEX 1400 x 1010 603 €	Ref. TEX 1600 x 1010 687 €	Ref. TEX 1800 x 1010 772 €
Ref. TEX 1400 x 1210 624 €	Ref. TEX 1600 x 1210 699 €	Ref. TEX 1800 x 1210 792 €

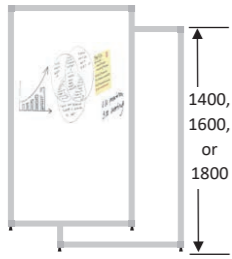

2 faces magnétiques émaillées écrivables + Mélaminé		
2 enamelled magnetic writable sides + Melamine		
2 emailiert magnetisch und beschreibbar Seiten + Melamin		

Ref. TMX 1400 x 610 335 €	Ref. TMX 1600 x 610 345 €	Ref. TMX 1800 x 610 376 €
Ref. TMX 1400 x 810 425 €	Ref. TMX 1600 x 810 437 €	Ref. TMX 1800 x 810 480 €
Ref. TMX 1400 x 1010 518 €	Ref. TMX 1600 x 1010 534 €	Ref. TMX 1800 x 1010 576 €
Ref. TMX 1400 x 1210 603 €	Ref. TMX 1600 x 1210 623 €	Ref. TMX 1800 x 1210 675 €
Ref. TMX 1400 x 1410 694 €	Ref. TMX 1600 x 1410 723 €	Ref. TMX 1800 x 1410 780 €
Ref. TMX 1400 x 1610 768 €	Ref. TMX 1600 x 1610 807 €	Ref. TMX 1800 x 1610 839 €

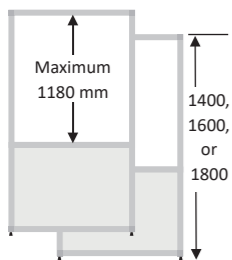

2 faces magnétiques émaillées écrivables + Tissu		
2 enamelled magnetic writable sides + Fabric		
2 emailiert magnetisch und beschreibbar Seiten + Stoff		

Ref. TTX 1400 x 610 359 €	Ref. TTX 1600 x 610 361 €	Ref. TTX 1800 x 610 403 €
Ref. TTX 1400 x 810 445 €	Ref. TTX 1600 x 810 462 €	Ref. TTX 1800 x 810 482 €
Ref. TTX 1400 x 1010 541 €	Ref. TTX 1600 x 1010 563 €	Ref. TTX 1800 x 1010 603 €
Ref. TTX 1400 x 1210 649 €	Ref. TTX 1600 x 1210 662 €	Ref. TTX 1800 x 1210 697 €
Ref. TTX 1400 x 1410 723 €	Ref. TTX 1600 x 1410 802 €	Ref. TTX 1800 x 1410 803 €
Ref. TTX 1400 x 1610 780 €	Ref. TTX 1600 x 1610 844 €	Ref. TTX 1800 x 1610 881 €

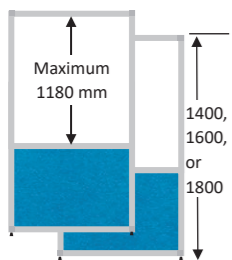

Hauteur Height Höhe	400 mm	600 mm	800 mm
Avec verre acrylique incolore, fumé gris ou opale de 3mm ou polycarbonate alvéolaire de 6mm, à préciser à la commande			
With 3mm colourless, gray tinted or opal acrylic glass or 6mm alveolar polycarbonate, please specify when ordering			
Mit 3mm Klar, grau Rauch oder Opal Acrylglas oder 6mm Klarpolycarbonat, bitte bei Bestellung angeben			
Ref. TPB 400 x 800 204 €	Ref. TPB 600 x 800 228 €	Ref. TPB 800 x 800 311 €	
Ref. TPB 400 x 1000 216 €	Ref. TPB 600 x 1000 240 €	Ref. TPB 800 x 1000 324 €	
Ref. TPB 400 x 1200 228 €	Ref. TPB 600 x 1200 276 €	Ref. TPB 800 x 1200 339 €	
Ref. TPB 400 x 1400 240 €	Ref. TPB 600 x 1400 324 €	Ref. TPB 800 x 1400 518 €	
Ref. TPB 400 x 1600 265 €	Ref. TPB 600 x 1600 349 €	Ref. TPB 800 x 1600 579 €	
Ref. TPB 400 x 1800 299 €	Ref. TPB 600 x 1800 397 €	Ref. TPB 800 x 1800 655 €	



Avec verre acrylique incolore, fumé gris ou opale de 3mm ou polycarbonate alvéolaire de 6mm, à préciser à la commande
 With 3mm colourless, gray tinted or opal acrylic glass or 6mm alveolar polycarbonate, please specify when ordering
 Mit 3mm Klar, grau Rauch oder Opal Acrylglas oder 6mm Klarpolycarbonat, bitte bei Bestellung angeben



Ref. TPA 600 x 800 194 €	Ref. TPA 800 x 800 228 €
Ref. TPA 600 x 1000 238 €	Ref. TPA 800 x 1000 272 €
Ref. TPA 600 x 1200 265 €	Ref. TPA 800 x 1200 316 €
Ref. TPA 600 x 1400 316 €	Ref. TPA 800 x 1400 369 €
Ref. TPA 600 x 1600 349 €	Ref. TPA 800 x 1600 410 €
Ref. TPA 600 x 1800 397 €	Ref. TPA 800 x 1800 466 €



PIETEMENTS + ROULETTES

FEET + CASTORS

FÜßE + ROLLEN

Nombre de pieds suivant l'implantation :

Number of feet required depends on the layout:

Zahl der Füße kommt darauf das Layout an:

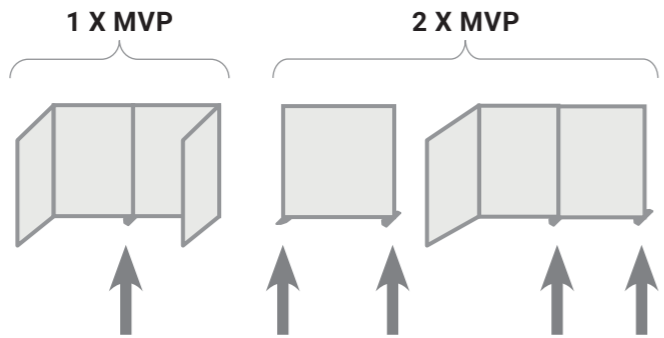

Pas de pied nécessaire pour ces implantations :

No feet required for these layouts:

Für diese Layouts sind keine Füße erforderlich:

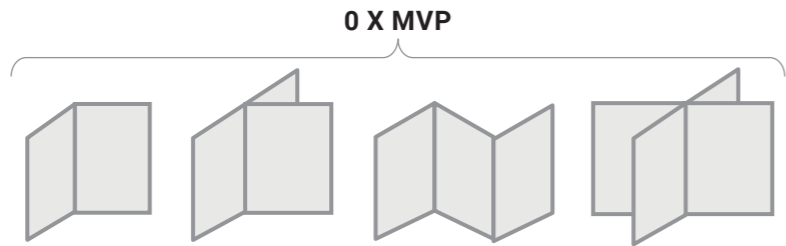

Pied sur platine plate
Prix unitaire

Foot on flat plate
Unit price

Fuß auf flacher Platte
Stückpreis

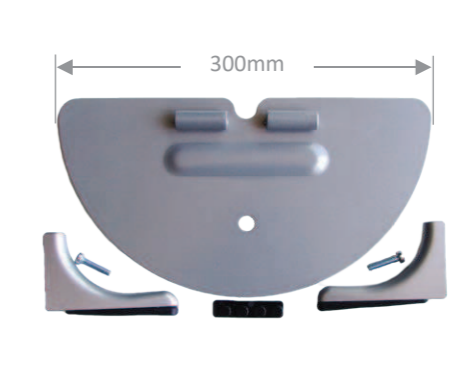

Ref. MVP 300 **34 €**

Pied réglable
Prix unitaire

Adjustable foot
Unit price

Verstellbarer Fuß
Stückpreis

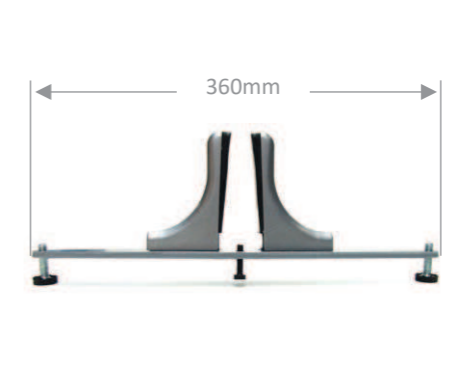

Ref. MVP 360 **34 €**

Kit complet 4 roulettes avec freins
+ 2 barres
(pour hauteur maxi 1800mm)

4 locking castor full set + 2 bars
(for maximum height 1800mm)

Komplettsatz mit 4 Rollen mit Bremsfunktion
(für maxi Höhe 1800mm)

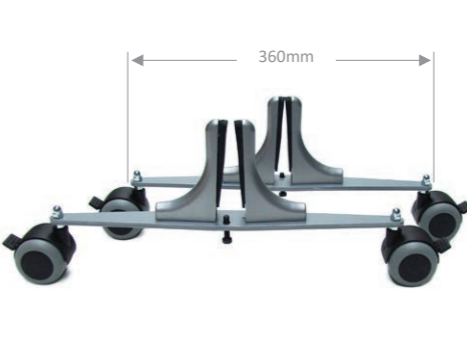

Ref. MVX 380 **79 €**

**TOLE PERFORÉE
MAGNÉTIQUE**

**MAGNETIC
PERFORATED
METAL SHEET**

**MAGNETISCH
LOCHBLECH**

**PANNEAUX POUR
BANQUE D'ACCUEIL**

**PANELS FOR
RECEPTION DESK**

**WÄNDE FÜR
EMPFANGSTHEKE**



Kit de montage livré avec chaque cloisonnette

Fitting set supplied with each screen

Ein Bausatz versorgt mit jeder Stellwand

Hauteur Height Höhe	1200 mm	1400 mm	1600 mm	1800 mm
	Tôle perforée magnétique acier laqué RAL 9006			
	RAL 9006 lacquered magnetic perforated metal sheet			
	Lackierten magnetisch Lochblech RAL 9006			
	Ref. MPP 1200 x 610 419 € Ref. MPP 1200 x 810 434 € Ref. MPP 1200 x 1010 440 €	Ref. MPP 1400 x 610 434 € Ref. MPP 1400 x 810 440 € Ref. MPP 1400 x 1010 445 €	Ref. MPP 1600 x 610 436 € Ref. MPP 1600 x 810 441 € Ref. MPP 1600 x 1010 448 €	Ref. MPP 1800 x 610 445 € Ref. MPP 1800 x 810 452 € Ref. MPP 1800 x 1010 458 €

Hauteur Height Höhe	1200 mm	1400 mm	1600 mm	1800 mm
	Tôle perforée magnétique acier laqué RAL 9006 + Mélaminé			
	RAL 9006 lacquered magnetic perforated metal sheet + Melamine			
	Lackierten magnetisch Lochblech RAL 9006 + Melamin			
	Ref. MPM 1400 x 610 257 € Ref. MPM 1400 x 810 313 € Ref. MPM 1400 x 1010 337 € Ref. MPM 1400 x 1210 482 € Ref. MPM 1400 x 1410 506 € Ref. MPM 1400 x 1610 530 €	Ref. MPM 1600 x 610 266 € Ref. MPM 1600 x 810 324 € Ref. MPM 1600 x 1010 349 € Ref. MPM 1600 x 1210 494 € Ref. MPM 1600 x 1410 530 € Ref. MPM 1600 x 1610 554 €	Ref. MPM 1800 x 610 274 € Ref. MPM 1800 x 810 337 € Ref. MPM 1800 x 1010 361 € Ref. MPM 1800 x 1210 530 € Ref. MPM 1800 x 1410 554 € Ref. MPM 1800 x 1610 579 €	

Hauteur Height Höhe	1200 mm	1400 mm	1600 mm	1800 mm
	Tôle perforée magnétique acier laqué RAL 9006 + Tissu			
	RAL 9006 lacquered magnetic perforated metal sheet + Fabric			
	Lackierten magnetisch Lochblech RAL 9006 + Stoff			
	Ref. MPT 1400 x 610 324 € Ref. MPT 1400 x 810 397 € Ref. MPT 1400 x 1010 434 € Ref. MPT 1400 x 1210 603 € Ref. MPT 1400 x 1410 651 € Ref. MPT 1400 x 1610 675 €	Ref. MPT 1600 x 610 337 € Ref. MPT 1600 x 810 419 € Ref. MPT 1600 x 1010 458 € Ref. MPT 1600 x 1210 651 € Ref. MPT 1600 x 1410 699 € Ref. MPT 1600 x 1610 723 €	Ref. MPT 1800 x 610 349 € Ref. MPT 1800 x 810 438 € Ref. MPT 1800 x 1010 469 € Ref. MPT 1800 x 1210 675 € Ref. MPT 1800 x 1410 723 € Ref. MPT 1800 x 1610 748 €	

Mélaminé 19mm
19mm melamine
19mm Melamin

Hauteur Height Höhe	1030 mm
	Ref. MMM 1030 x 800 142 € Ref. MMM 1030 x 825 144 € Ref. MMM 1030 x 1000 160 € Ref. MMM 1030 x 1200 180 € Ref. MMM 1030 x 1400 199 € Ref. MMM 1030 x 1600 212 €

Tissu
Fabric
Stoff

Ref. MTT 1030 x 800 180 € Ref. MTT 1030 x 825 183 € Ref. MTT 1030 x 1000 235 € Ref. MTT 1030 x 1200 249 € Ref. MTT 1030 x 1400 266 € Ref. MTT 1030 x 1600 276 €
Ref. MTT 1030 x R800 609 €

Tôle perforée acier laqué RAL 9006
RAL 9006 lacquered perforated metal sheet
Lackierten Lochblech RAL 9006

Ref. MPP 1030 x 800 271 € Ref. MPP 1030 x 825 272 € Ref. MPP 1030 x 1000 276 € Ref. MPP 1030 x 1200 314 € Ref. MPP 1030 x 1400 408 € Ref. MPP 1030 x 1600 434 €
Ref. MPP 1030 x R800 709 €

Tablette en verre Securit dépoli 8mm avec supports MCT 230
8mm frosted Securit glass slab with holders MCT 230
Glasplatte, 8mm Securit Mattglas mit Stützer MCT 230

Ref. MCW 300 x 800 229 € Ref. MCW 300 x 1000 298 € Ref. MCW 300 x 1200 335 € Ref. MCW 300 x 1400 355 € Ref. MCW 300 x 1600 375 €
Ref. MCW 300 x R800 597 €

Support pour tablette bois ou verre
Holder for glass or wooden slab
Stütze für Holz oder Glasplatte



Ref. MCT 230 **59 €**



 **POSTES DE TRAVAIL**

 **WORKSTATIONS**

 **ARBEITSPLÄTZE**

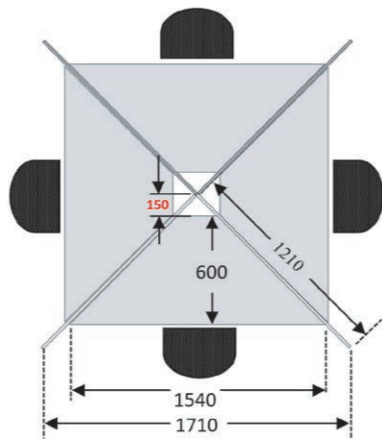
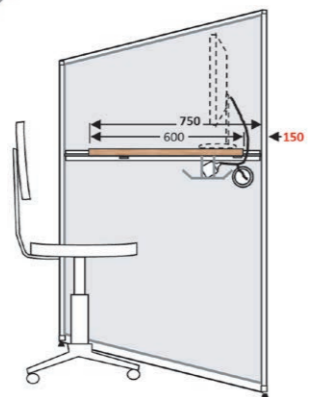
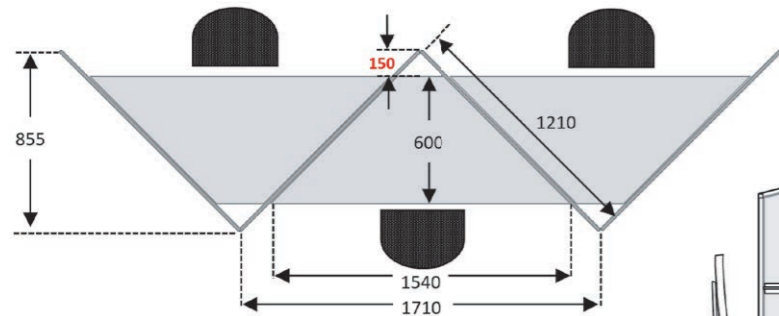

Rail aluminium pour fixation plateau ou accessoires (voir page 40).
A intégrer dans la cloison.

Aluminum profile for desk surfaces or accessories (see page 40).
To be integrated into the screen.

Alu-Profil für Tischplatten-Befestigung oder Zubehör (siehe Seite 40).
In die Wand einzulassen.

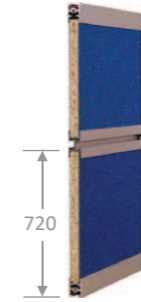

- Ref. MVH 100/ 610 **19 €**
- Ref. MVH 100/ 810 **23 €**
- Ref. MVH 100/ 1010 **25 €**
- Ref. MVH 100/ 1210 **29 €**
- Ref. MVH 100/ 1410 **32 €**
- Ref. MVH 100/ 1610 **35 €**
- Ref. MVH 100/ 1810 **40 €**

4 Supports pour plateau

4 Holders for desk surfaces

4 Halter für Tischplatte



Ref. MVH 110 **15 €**

Plateau mélaminé blanc ou gris
28mm + 4 supports MVH 110

28mm thick white or grey desk surface
+ 4 holders MVH 110

28mm Melamin Tischplatte weiss oder grau + 4 Halterungen MVH 110

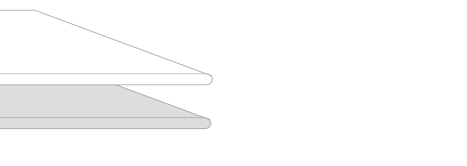

Ref. MVH 600 x TRAP **90 €**

Prise compact type E
avec chargeur USB 5V / 2,4A

E type compact desk power plug
with 5V / 2,4A USB charger

Kompakte Typ E Schreibtischsteckdose
mit USB-Ladefunktion 5V / 2,4A



Ref. MVH 213 **67 €**

Goulotte pour câbles longueur 420mm à fixer sous le plateau

Cable support 420mm long to fix under the desk surface

Kabelwanne 420mm lang unter Tischplatte zu befestigen

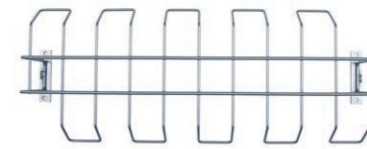

Ref. MVH 212 **46 €**

Passage pour câbles
(à prévoir à la commande)

Cable pathway
(to be specified when ordered)

Kabeldurchführung
(Bei Bestellung angeben)

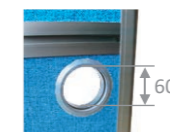
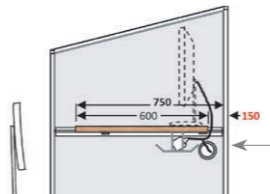

Ref. MVF 111 **11 €**

**POSTES DE TRAVAIL
+ CALL CENTER**

**WORKSTATIONS
+ CALL CENTER**

**ARBEITSPLÄTZE
+ CALL CENTER**

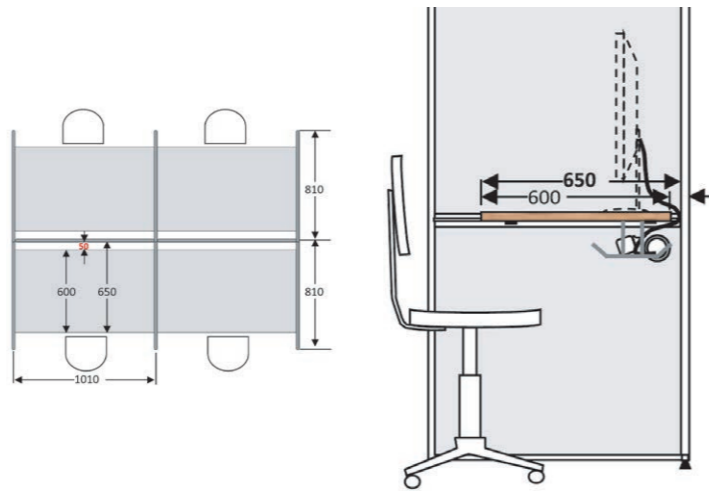
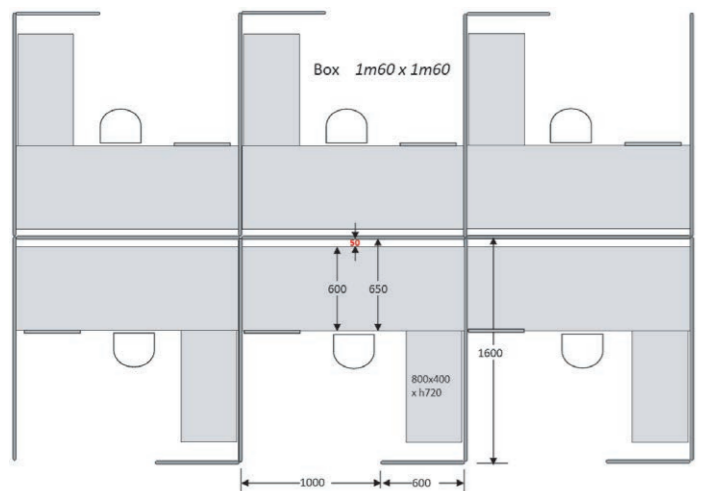

Rail aluminium pour fixation plateau ou accessoires (voir page 40).
A intégrer dans la cloison.

Aluminum profile for desk surfaces or accessories (see page 40).
To be integrated into the screen.

Alu-Profil für Tischplatten-Befestigung oder Zubehör (siehe Seite 40).
In die Wand einzulassen.

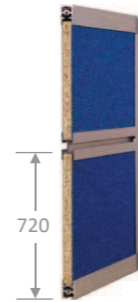

- Ref. MVH 100/ 610 **19 €**
- Ref. MVH 100/ 810 **23 €**
- Ref. MVH 100/ 1010 **25 €**
- Ref. MVH 100/ 1210 **29 €**
- Ref. MVH 100/ 1410 **32 €**
- Ref. MVH 100/ 1610 **35 €**
- Ref. MVH 100/ 1810 **40 €**

4 Supports pour plateau

4 Holders for desk surfaces

4 Halter für Tischplatte



Ref. MVH 110 **15 €**

Plateau mélaminé blanc ou gris
28mm + 4 supports MVH 110

28mm thick white or grey
desk surface + 4 holders MVH 110

28mm Melamin Tischplatte weiss
oder grau + 4 Halterungen MVH 110

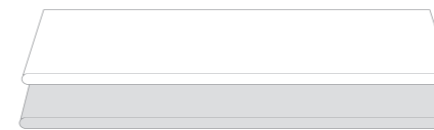

- Ref. MVH 600 x 800 **65 €**
- Ref. MVH 600 x 1000 **83 €**
- Ref. MVH 600 x 1200 **88 €**
- Ref. MVH 600 x 1400 **89 €**
- Ref. MVH 600 x 1600 **90 €**

Prise compact type E
avec chargeur USB 5V / 2,4A

E type compact desk power plug
with 5V / 2,4A USB charger

Kompakte Typ E Schreibtischsteckdose
mit USB-Ladefunktion 5V / 2,4A



Ref. MVH 213 **67 €**

Goulotte pour câbles longueur
420mm à fixer sous le plateau

Cable support 420mm long to fix
under the desk surface

Kabelwanne 420mm lang unter
Tischplatte zu befestigen

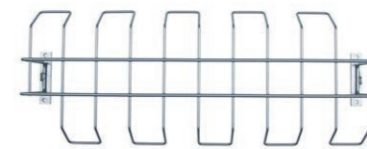

Ref. MVH 212 **46 €**

Passage pour câbles
(à prévoir à la commande)

Cable pathway
(to be specified when ordered)

Kabeldurchführung
(Bei Bestellung angeben)

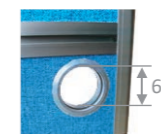
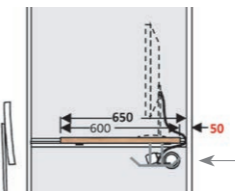

Ref. MVF 111 **11 €**



**REHAUSSE +
ÉCRAN EN VERRE**



**GLASS DESK
SCREEN + TOPPER**



**GLAS-
WÄNDE + AUFSATZ**



Rehausse en verre
trempé dépoli 5mm
5mm frosted tempered glass
(securit)
Aufsatz aus gehärtetem Mattglas
5mm stark (securit)

Ref. MGD 250/ 790 **83 €**
Ref. MGD 250/ 990 **102 €**
Ref. MGD 250/ 1190 **120 €**
Ref. MGD 250/ 1390 **137 €**
Ref. MGD 250/ 1590 **162 €**
Ref. MGD 250/ 1790 **186 €**

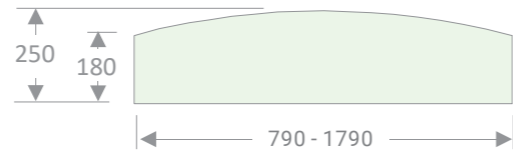

Clip pour verre
de 4 à 10mm avec écrou
Clip for 4 to 10mm glass
with nut
Klip für 4 bis 10mm starkes Glas
mit Mutter

Ref. MVU 002 **11 €**

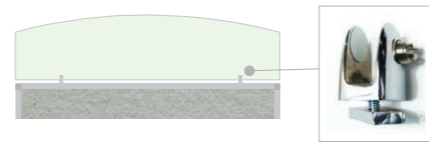

Ecrans en verre
trempé dépoli 5mm
Glass desk screens
5mm frosted tempered glass
Glaswände
aus gehärtetem Mattglas 5mm stark

Ref. MGD 450/ 790 **123 €**
Ref. MGD 450/ 990 **150 €**
Ref. MGD 450/ 1190 **175 €**
Ref. MGD 450/ 1390 **201 €**
Ref. MGD 450/ 1590 **233 €**
Ref. MGD 450/ 1790 **265 €**

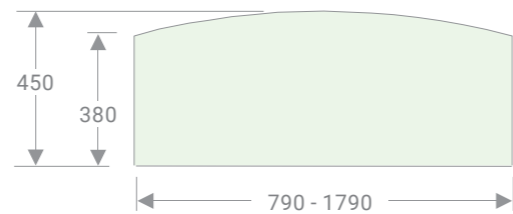

Pince bureau métallique
+ clip pour verre de 4 à 10mm
Metal desk clamp
+ clip for 4 to 10mm glass
Tischklammer
+ Klip für Glas von 4 bis 10mm

Ref. MVM 280 **29 €**
Ref. MVM 380 **29 €**

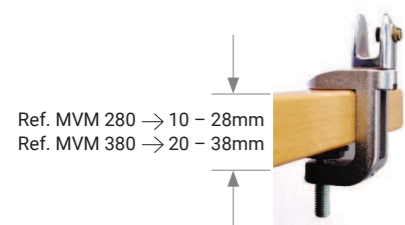

 **ACCESSOIRES**

 **ACCESSORIES**

 **ZUBEHÖR**



Rail aluminium pour accessoires sur les 2 faces de la cloison. A prévoir à la fabrication.
Aluminium profile for accessories on both sides of the screen. Must be specified prior to manufacture.
Alu-Profil für Zubehör an beiden Seiten der Trennwand. Bei der Herstellung einzuplanen.

Plaque pour fixation accessoires 350 x H 330mm
 A enclencher sur le profilé haut de la cloison.
Accessory plate 350 x H 330mm, interlocks on to the aluminum profile of the screen.
Platte zur Befestigung von Zubehör 350 x H 330mm, zum einrasten am oberen Profil der Trennwand.

Bac à Courier 335 x 250 x 50mm
Paper tray 335 x 250 x 50mm
Ablagefach 335 x 250 x 50mm

Pot à crayon
Pen holder
Stift-Cup

Support tablette ou téléphone 80 x 60mm
Tablet or cell phone holder 80 x 60mm
Tablet- / Mobiltelefon-Halterung 80 x 60mm

Support inclinable et orientable pour écran LCD de 10 à 23"
 Peut être fixé directement sur la cloison avec vis traversantes ou sur la plaque Ref. MVH 200.
10-23" LCD monitor mount full rotation
 Can be fixed directly on the screen with screws through the panel or on the plate Ref. MVH 200.
Neig- und schwenkbare Halterung für 10-23" LCD-Monitor
 Kann direkt an der Wand mit durchgehenden Schrauben oder an der Platte Ref. MVH 200 befestigt werden.

Ref. MVH 100/ 610 **19 €**
 Ref. MVH 100/ 810 **23 €**
 Ref. MVH 100/ 1010 **25 €**
 Ref. MVH 100/ 1210 **29 €**
 Ref. MVH 100/ 1410 **32 €**
 Ref. MVH 100/ 1610 **35 €**
 Ref. MVH 100/ 1810 **40 €**

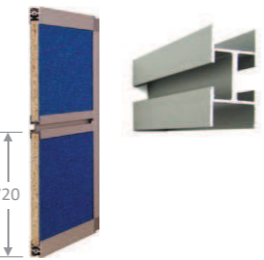

Ref. MVH 200 **43 €**



Ref. MVH 201 **30 €**

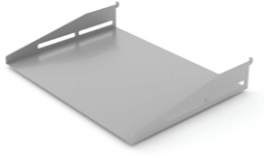

Ref. MVH 204 **15 €**



Ref. MVH 206 **11 €**



Ref. MVH 209 **29 €**



Crochet métallique



Crochet porte manteau



Profilé d'obturation en PVC souple gris



Sabot à poser sur le bureau
 Prix unitaire



Metal hook



Coatrack hook

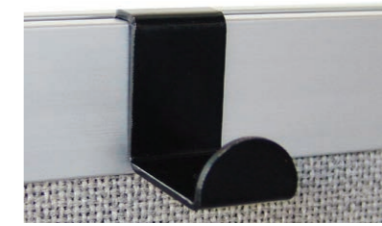

Shutterprofile flexible grey PVC



Base to place on the desk
 Unit price



Metalhaken

Ref. MVD 200 **9 €**

Kleiderhaken

Ref. MVC 111 **10 €**

Verstopfprofile aus grau Weich-PVC

Ref. MVX 001 **4 € / m**

Sockel auf den Tisch zu lege
 Stückpreis

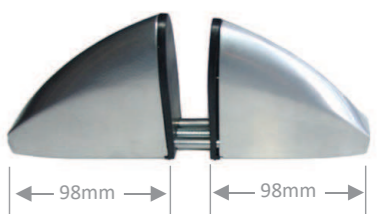

Ref. MVZ 200 **35 €**



**SOLUTIONS
ACOUSTIQUES**



**ACOUSTIC
SOLUTIONS**



**AKUSTISCHE
LÖSUNGEN**

Panneaux suspendus et muraux
Super-Acoustique
Tests acoustiques page 17

Hanging and wall panels
Super-Acoustic
Acoustic tests page 17

Hänge- und wandpaneele
Super-Akustik
Akustikteste Seite 17



Hauteur Height Höhe	1000 mm	1200 mm	1400 mm	1600 mm			
Ref. ATT 1000 x 600	216 €	Ref. ATT 1200 x 600	278 €	Ref. ATT 1400 x 600	306 €	Ref. ATT 1600 x 600	330 €
Ref. ATT 1000 x 800	265 €	Ref. ATT 1200 x 800	336 €	Ref. ATT 1400 x 800	402 €	Ref. ATT 1600 x 800	412 €
Ref. ATT 1000 x 1000	321 €	Ref. ATT 1200 x 1000	405 €	Ref. ATT 1400 x 1000	433 €	Ref. ATT 1600 x 1000	443 €
Ref. ATT 1000 x 1200	405 €	Ref. ATT 1200 x 1200	419 €	Ref. ATT 1400 x 1200	462 €	Ref. ATT 1600 x 1200	482 €
Ref. ATT 1000 x 1400	433 €	Ref. ATT 1200 x 1400	462 €	Ref. ATT 1400 x 1400	499 €	Ref. ATT 1600 x 1400	549 €
Ref. ATT 1000 x 1600	443 €	Ref. ATT 1200 x 1600	482 €	Ref. ATT 1400 x 1600	534 €		

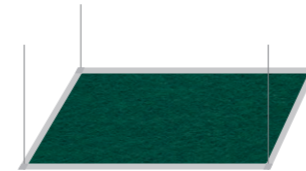

Fixation pour panneaux suspendus
cables longueur réglable
(maximum 2 m) vendus par deux

Fixing for hanging panels
Adjustable length cables
(maximum 2 m) sold by two

Befestigung für Hängepaneele
Kabel mit einstellbarer Länge
(maximal 2 m) zu zweit verkauft



Vertical
1 x APD



Horizontal
2 x APD



Ref. APD 29 €

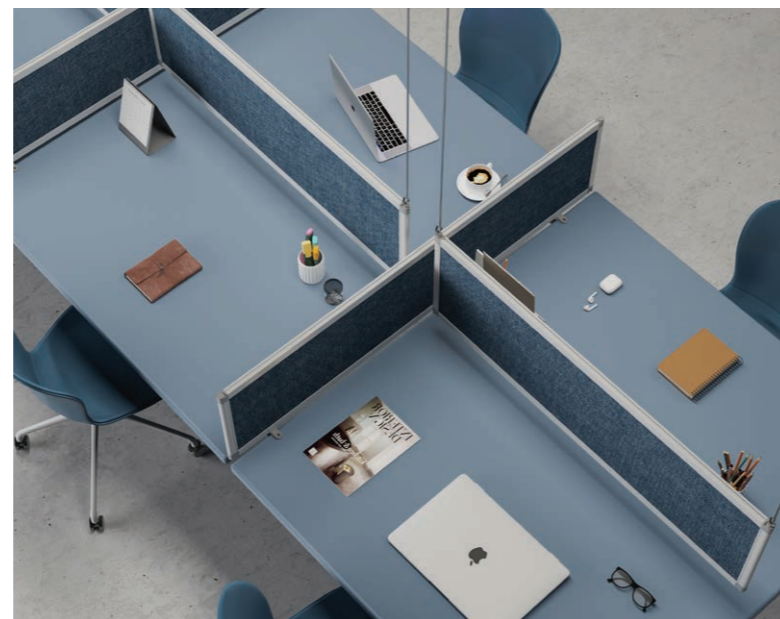

Fixation pour panneaux muraux

Fixing for wall panels

Befestigung für Wandpaneele

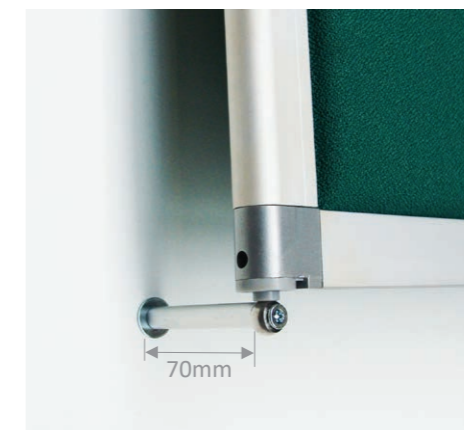

Ref. APM 23 €



 **CLOISONS MOBILES
À ANGLE DROIT**

 **FREESTANDING
ANGLE PARTITIONS**

 **BEWEGLICHE
ECKTRENNWÄNDE**



Les panneaux mobiles à angle droit se rangent facilement dans un coin.
The angle partitions can easily be stored in a room corner.
Die bewegliche Trennwände können einfach in einer Ecke eingestellt werden.



Les Cloisons Reyem à angle droit sur 3 roulettes permettent de séparer rapidement vos espaces, peuvent être utilisées dans des salles polyvalentes, musées, expositions...

The three-caster free-standing partitions by Reyem are a fast and easy solution to separate your spaces. They can be used in function rooms, museums, exhibitions and many other locations...

Die rechtwinkligen Reyem Trennwände auf 3 Rollen ermöglichen Ihnen eine schnelle Raumteilung und können in Mehrzweckhallen, Museen, Ausstellungsräumen usw. eingesetzt werden.

- ✓ **BONNE STABILITE**
- ✓ **FACILE A DEPLACER ET A ASSEMBLER**
- ✓ **GAIN DE PLACE LORS DU RANGEMENT**

- ✓ **A STABLE SOLUTION**
- ✓ **EASY TO TRANSPORT AND ASSEMBLE**
- ✓ **SAVE VALUABLE STORAGE SPACE**

- ✓ **GUTE STABILITÄT**
- ✓ **EINFACH BEWEGBAR & ZUSAMMENBAUBAR**
- ✓ **PLATZSPAREND VERSTAUBAR**

Ensemble de deux cloisons + kit 3 roulettes
Mélaminé blanc de 8 mm

Pour d'autres coloris ou PVC blanc de 8 mm classé feu **M1 / B, s3, do** veuillez nous consulter.

Two partitions + 3 castor kit
8mm white melamine

For other colours, or 8mm white PVC with fire safety classification **B, s3, do**, please contact us.

Einheit aus zwei Trennwänden + 3 Rollen satz
8 mm weiß Melamin

Für andere Farbe, oder 8 mm Weiß PVC, Feuersicherung Class **B, s3, do**, kontaktieren Sie uns.

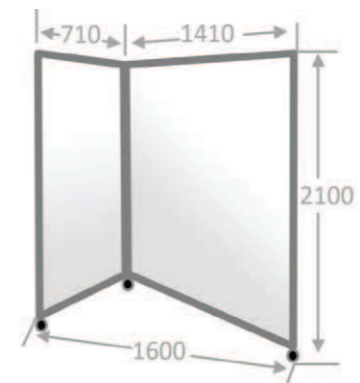

Ref. PAS 2100 1410 / 710 **519 €**

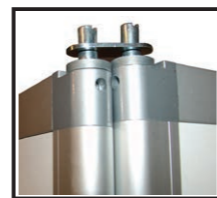

Roulettes avec frein
Locking castors
Rollen mit Bremsfunktion

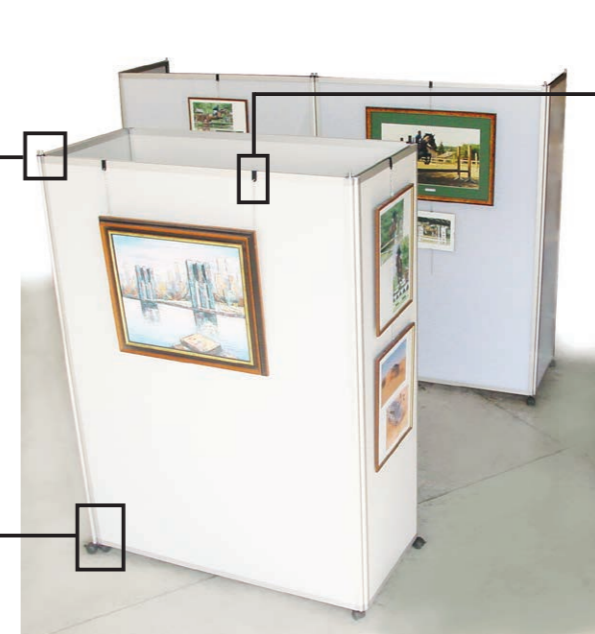

Crochet métallique
Metal hook
Metallhaken
Ref. MVD 200 **9 €**

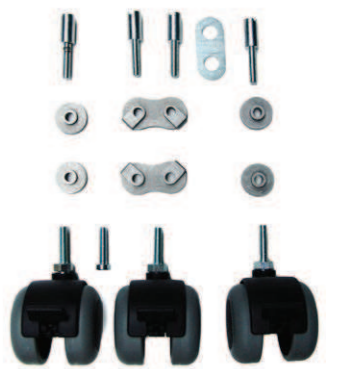

Kit 3 roulettes uniquement
3 castor kit only
Einzel 3 Rollensatz
Ref. EP 57 **47 €**



CONDITIONS DE TRANSPORT

Frais de port et d'emballage pour la **ZONE A** :

Pour une commande prix tarif :
de 0 à 1 500 € = **100 €**
de 1 501 à 3 000 € = **50 €**
supérieur à 3 001 € = **FRANCO**

Frais de port et d'emballage pour la **ZONE B** :

Pour une commande prix tarif :
de 0 à 1 500 € = **120 €**
de 1 501 à 3 000 € = **60 €**
supérieur à 3 001 € = **FRANCO**

Frais de port et d'emballage pour les **AUTRES DESTINATIONS**, veuillez nous consulter.



CONDITIONS OF TRANSPORT

Shipping and packing costs for **ZONE A**:

For an order:
between €0 and €1500 price list = **€100**
between €1501 and €3000 price list = **€50**
over €3001 price list = **FREE DELIVERY**

Shipping and packing costs for **ZONE B**:

For an order:
between €0 and €1500 price list = **€120**
between €1501 and €3000 price list = **€60**
over €3001 price list = **FREE DELIVERY**

Shipping and packing costs for **OTHER DESTINATIONS**, please contact us.



BEFÖRDERUNGS-BEDINGUNGEN

Porto- und Verpackungskosten für die **ZONE A**:

Für eine Bestellung:
von 0 bis 1 500 € Listenpreis = **100 €**
von 1 501 bis 3 000 € Listenpreis = **50 €**
ab 3 001 € Listenpreis = **PORTOFREI**

Porto- und Verpackungskosten für die **ZONE B**:

Für eine Bestellung:
von 0 bis 1 500 € Listenpreis = **120 €**
von 1 501 bis 3 000 € Listenpreis = **60 €**
ab 3 001 € Listenpreis = **PORTOFREI**

Porto- und Verpackungskosten für **ANDERE LANDER**, bitte kontaktieren Sie uns.

